

Night_Presotto_Passion for details

WARDROBES,
BEDS AND
NIGHT SETS

NIGHT

PRESOTTO

INDEX NIGHT

HINGED, SLIDING,
COPLANAR DOORS
WARDROBES
WALK-IN CLOSET
BEDS / NIGHT SETS
SMALL ARMCHAIRS
POUFS / BENCHES
WRITING DESKS / MIRRORS
ARMADI AD ANTE
BATTENTI, SCORREVOLI,
COMPLANARI
CABINE ARMADIO
LETTI / GRUPPI NOTTE
POLTRONCINE
POUF / PANCHE
SCRITTOI / SPECCHI

Night_System program

Hinged Door Wardrobes / Armadi ante Battenti

LISCIA	10 / 13
NEWONE	14 / 17
SKETCH	18 / 21
ALIBI	22 / 25
NAOS	26 / 29
TAU	30 / 33
GLASS	34 / 37
ASTIPALEA + ANTA TELAIO	
VETRO	38 / 39
ASTIPALEA	40 / 41
QUERINI	42 / 47

Sliding Door Wardrobes / Armadi ante Scorrevoli

QUERINI	50 / 53
SKETCH	54 / 57
LISCIA	58 / 61
TRIS	62 / 65
TRIS TV	66 / 69
L12	70 / 73
GLASS	74 / 77
KALEIDOS	78 / 81

Coplanar Door Wardrobes / Armadi ante Complanari

ASTIPALEA	82 / 85
TAU	86 / 89

Walk-in Closet / Cabine Armadio

TECNOPOLIS FREE	
METAL + NAOS	92 / 95
TECNOPOLIS FREE	
METAL WOOD	96 / 99
TECNOPOLIS FREE	
WOOD	100 / 103
VARIUS	104 / 107

Special Solutions / Soluzioni Speciali

MANSARDA	108 / 111
----------	-----------

Beds / Letti

WING	114 / 117
FEZ	118 / 121
DOLLY LARA	122 / 125
DOLLY ROSE	126 / 129
NIOBE	130 / 133
CALI	134 / 137
PLANA	138 / 141
RELEVÈ	142 / 145
MEETING UP	146 / 149
AQUA	150 / 153
ZERO	154 / 157

Night Sets / Gruppi Notte

SIGMA	160 / 161
SIBARI	162 / 163
DOLLY	164 / 165
INSIDE	166 / 167
WING	168 / 169
CLUB	170 / 171
ELLE	172 / 173
JAZZ	174 / 175
MEMORIES	176 / 177
GLOBO	178 / 179

Small Armchairs / Poltroncine

FULLER	182 / 183
CLARKE	184
MILO	185

Poufs_Benches / Pouf_Panche

DAMA	188 / 189
PILAR	190 / 191
QUADRATO	192 / 193
DORMEUSE	194
SIGMUND	195
CALI	196 / 197

Writing Desks / Scrivanie

CADDY	200 / 201
RELEVÈ	202 / 203
SQUID	204 / 205
BLOOM	206 / 207

Mirrors / Specchi

MIMESI	208 / 209
TUTTOSPECCHIO	210 / 211

Technical features / Schede tecniche

ARMADI	214 / 219
PRODOTTI	220 / 237

Night_System program



La zona notte rappresenta l'area dove Presotto affonda le proprie radici. La collezione armadi TecnoPolis è stata allargata con New One, Astipalea, Sketch e Querini in tutte le versioni con ante battenti, scorrevoli e complanari. TecnoPolis Free wood e metal aprono nuovi orizzonti dell'universo cabina, mentre l'inserimento dei Complementi a giorno e Display aggiungono funzioni importanti, quali scrittoio, cassettiere e vani a giorno. Completano la zona notte i letti, gruppi notte: comò, comodini, settimanali, scrittoi, poltroncine, pouf, panche e specchi.

The sleeping area represents the area where Presotto express its own roots. The TecnoPolis closet collection has been expanded with New One, Astipalea, Sketch and Querini in all hinged, sliding and coplanar doors versions. TecnoPolis Free wood and metal open new horizons of the walk-in universe, while the inclusion of day Complementi and Display adds important functions, such as desks, drawer units and open compartments. Beds, sleeping groups complete the sleeping area: drawer units, nightstands, chests of drawer, desks, armchairs, pouf, benches and mirrors.

WARDROBES, BEDS AND NIGHT SETS

NIGHT

PRESOTTO

Hinged Door Wardrobes /Armadi ante Battenti



L'armadio battente in 12 versioni rappresenta la più vasta offerta dimensionale e cromatica, l'unico armadio con basi in alluminio. Ricca è l'attrezzatura interna: cassettiere, ripiani, portascarpe, portamaglioni, portapantaloni e portacravatte. Completa l'attrezzatura interna l'illuminazione orizzontale di ripiani, coperchi e/o in verticale su fianchi e divisori.

The hinged doors wardrobes in 12 versions represent the largest dimensional and color offer, the only wardrobe with aluminum plinths. The internal equipment is very rich: drawers, shelves, shoe racks, sweater racks, trouser racks and tie racks. The interior equipment is completed by a horizontal lighting of shelves, wardrobe top and/or in vertical on sides and dividers.



ARMADIO BATTENTE
L 4025 H 2544 P 604
HINGED DOOR WARDROBE
W 158 1/2" H 100 1/8" D 23 3/4"

ARMADIO BATTENTE INCASSATO CON ANTE IN FINITURA LACCATO OPACO GRIGIO POLVERE E MANIGLIE LIPSI IN BRUNITO SATINATO. A SINISTRA, LETTO DOLLY ROSE E COMODINI DOLLY. / RECESSED HINGED DOOR WARDROBE WITH DOORS IN GRIGIO POLVERE MATT LACQUERED FINISH AND LIPSI HANDLES IN SATIN BURNISHED. ON LEFT, DOLLY ROSE BED AND DOLLY NIGHTSTANDS.

\ LISCIA # 01

Hinged Door Wardrobes

Particolare apertura anta
con maniglia Lipsi.
L'anta è dotata di cerniere
di serie soft closing.

/
Detail of door opening
with Lipsi handle.
The door is equipped
with standard soft closing
hinges.





ARMADIO BATTENTE
L. 4025 H. 2544 P. 604
HINGED DOOR WARDROBE
W 158 1/2" H 100 1/8" D 23 3/4"

ARMADIO BATTENTE NEW ONE IN FINITURA LACCATO OPACO BIANCO GIGLIO. L'ANTA È CARATTERIZZATA DA UN PROFILO MANIGLIA A TUTTA ALTEZZA METAL STANDARD PLATINO E DOTATA DI CERNIERE DI SERIE SOFT CLOSING. STRUTTURA INTERNA IN NOBILITATO COMFORT DESIGN. POLTRONCINA MILO E TAVOLINO MW. / NEW ONE HINGED DOOR WARDROBE IN BIANCO GIGLIO MATT LACQUERED FINISH. THE DOOR FEATURES A FULL-HEIGHT PLATINUM METAL STANDARD HANDLE PROFILE AND IS EQUIPPED WITH STANDARD SOFT CLOSING HINGES. INTERIOR STRUCTURE IN COMFORT DESIGN MELAMINE. MILO ARMCHAIR AND MW COFFEE TABLE.





ARMADIO BATTENTE
L 4025 H 2544 P 604
HINGED DOOR WARDROBE
W158 ½" H 100 1/8" D 23 ¾"

ARMADIO BATTENTE SKETCH IN ESSENZA EUCALIPTO DARK CON ATTREZZATURE A GIORNO: SCRITTOIO FLY, RIPIANI E COPERCHIO, IL TUTTO IN ESSENZA. L'ANTA È CARATTERIZZATA DA UN PROFILO MANIGLIA A TUTTA ALTEZZA IN METAL STANDARD BRONZO. STRUTTURA E ATTREZZATURA INTERNA IN NOBILITATO COMFORT DESIGN. SCRITTOIO FLY, QUI FOTOGRAFATO, CON POUF DAMA IN CUIO INTRECCIATO. / SKETCH HINGED DOOR WARDROBE IN EUCALYPTUS DARK VENEER WITH OPEN EQUIPMENT: FLY DESK, SHELVES AND COVER, COMPLETELY IN WOOD VENEER. THE DOOR FEATURES A FULL-HEIGHT HANDLE PROFILE IN BRONZE METAL STANDARD. FRAME AND INTERIOR EQUIPMENT IN COMFORT DESIGN MELAMINE. FLY WRITING DESK, HERE IN THE PHOTO, WITH DAMA POUF IN WOVEN LEATHER.

\ SKETCH # 03

Hinged Door Wardrobes

Particolare dettaglio anta in Eucalipto Dark con fresate verticali e profilo maniglia in Metal Standard Bronzo.

L'anta è dotata di cerniere di serie soft closing. Sotto, rappresentata anche in versione Bianco Giglio con profilo maniglia in Metal Standard Peltro.

/
Detail of door with vertical millings in Eucalyptus Dark and handle profile in Bronze Metal Standard. The door is equipped with standard soft closing hinges. Below, also shown in Bianco Giglio version with handle profile in Pewter Metal Standard.

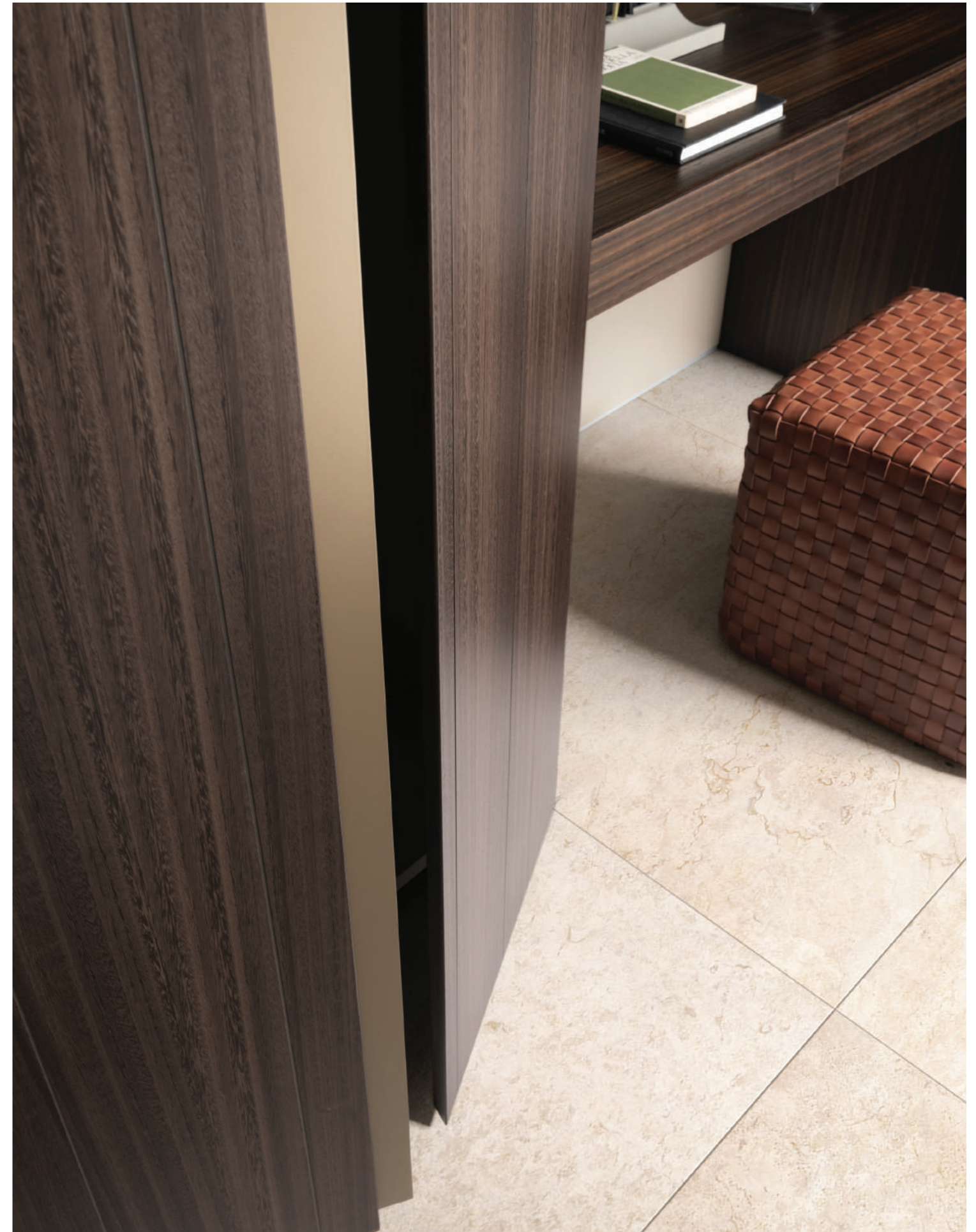
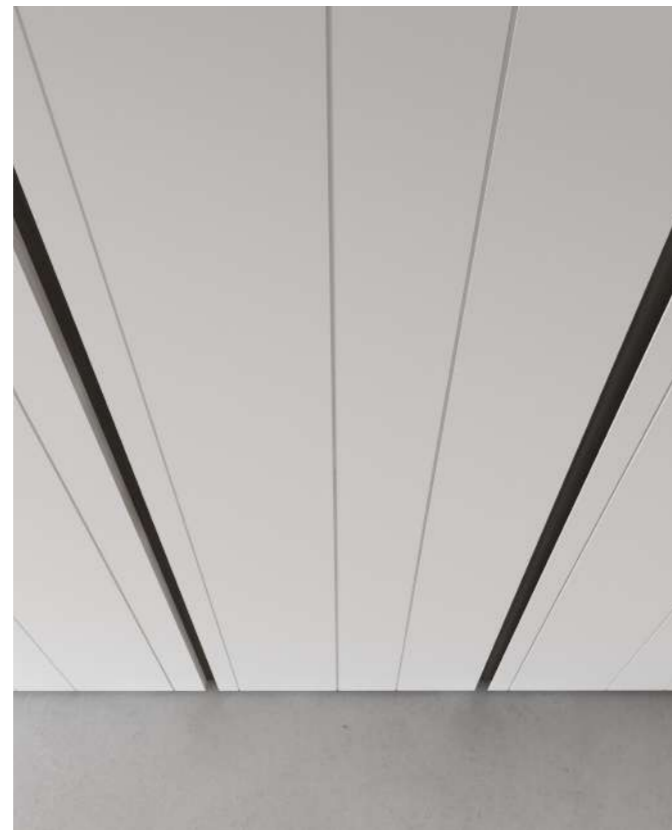
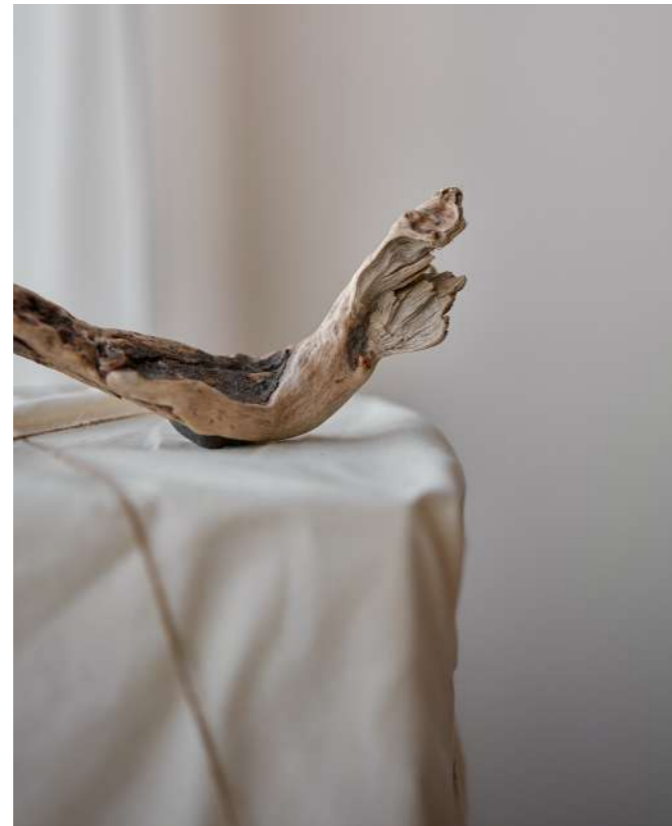



ARMADIO BATTENTE
L 3625 H 2544 P 604
HINGED DOOR WARDROBE
W 142 3/4" H 100 1/8" D 23 3/4"

ARMADIO BATTENTE CON ANTA ALIBI IN FINITURA GRIGIO AGATA, CARATTERIZZATA PER LA SUA PARTICOLARE LAVORAZIONE DELL'INSERTO MANIGLIA CHE PUÒ ESSERE SIA IN VERTICALE CHE IN ORIZZONTALE, QUI IN FINITURA PIETRA GALAXY. L'ANTA È DOTATA DI CERNIERE DI SERIE SOFT CLOSING. / HINGED DOOR WARDROBE WITH ALIBI DOOR IN GRIGIO AGATA FINISHING CHARACTERIZED BY ITS SPECIAL PROCESSING OF THE HANDLE INSERT THAT CAN BE EITHER VERTICAL OR HORIZONTAL, HERE IN GALAXY STONE FINISH.

\ ALIBI #05

Hinged Door Wardrobes

Particolare anta Alibi con inserto sia orizzontale che verticale in finitura Noce Canaletto. Sotto, esempio di configurazione con inserto in pietra Cooper.

/
Detail of Alibi door with both horizontal and vertical insert in Canaletto Walnut finish. Below, example of configuration with handle insert in Cooper stone.





ARMADIO BATTENTE
L 4025 H 2544 P 604
HINGED DOOR WARDROBE
W 158 1/2" H 100 1/8" D 23 3/4"

ARMADIO BATTENTE NAOS RIVESTITO IN PELLE SOFT, CARATTERIZZATA DA UN PROFILO METALLICO VERNICIATO GRIGIO LONDRA CON MANIGLIE APPLICATE SUI DUE LATI. OGNI SINGOLA ANTA È CARATTERIZZATA DA UNA DOPPIA CUCITURA ORIZZONTALE, ALL'ALTEZZA DELLA MANIGLIA, ESCLUSIVAMENTE PER LA VERSIONE RIVESTITA IN PELLE O ECOPELLE.
/ NAOS HINGED DOOR WARDROBE UPHOLSTERED IN SOFT LEATHER, CHARACTERIZED BY A GRIGIO LONDRA PAINTED METAL PROFILE WITH HANDLES APPLIED ON BOTH SIDES. EACH INDIVIDUAL DOOR IS CHARACTERIZED BY A DOUBLE HORIZONTAL SEAM, JUST NEAR THE HANDLE, EXCLUSIVELY FOR THE VERSION COVERED IN LEATHER OR ECO-LEATHER.

Particolare maniglia e cucitura orizzontale.
Particolare anta aperta con struttura interna in nobilitato Comfort Design. L'anta è dotata di cerniere di serie soft closing.

/
Detail handle and horizontal seam.
Detail of open door with Comfort Design melamine interior structure.
The door is equipped with standard soft closing hinges.





ARMADIO BATTENTE
L 4025 H 2544 P 604
HINGED DOOR WARDROBE
W 158 1/2" H 100 1/8" D 23 3/4"

ARMADIO TAU IN FINITURA GRIS BEIGE CON PARTICOLARE MANIGLIA IN FINITURA METAL STANDARD BRONZO. A DESTRA TAVOLINO IRORI CON SEDIE EVIA. / TAU HINGED DOOR WARDROBE IN GRIS BEIGE FINISH WITH SPECIAL HANDLE IN BRONZE METAL STANDARD FINISHING. ON THE RIGHT IRORI COFFEE TABLE WITH EVIA CHAIRS.

A destra, particolare maniglia in Metal Standard Bronzo. A sinistra, ripiano in vetro con bordo in alluminio verniciato Grigio Londra; struttura interna in nobilitato Eucalipto.

/
On the right, detail of handle in Bronze Metal Standard. On the left, glass shelf with Grigio Londra varnished aluminum edge; internal structure in Eucalyptus melamine.





ARMADIO BATTENTE
L 4025 H 2544 P 604
HINGED DOOR WARDROBE
W 158 1/2" H 100 1/8" D 23 3/4"

ARMADIO ANTE GLASS IN SPECCHIO BRONZATO E PROFILO CORNICE IN METAL STANDARD BRONZO CHE INCORNICIA L'ANTA. L'ANTA GLASS SI DIFFERENZIA PER IL SUO PARTICOLARE PROFILO A TUTTA ALTEZZA SU UN LATO CHE CREA LA PRESA MANIGLIA, QUI IN METAL STANDARD BRONZO. A DESTRA LETTO NIOBE. A SINISTRA, SCRITTOIO BLOOM CON POLTRONCINA INDIRA. / GLASS HINGED DOOR WARDROBE IN BRONZED MIRROR AND PROFILE IN BRONZE METAL STANDARD FRAMING THE DOOR. GLASS DOOR IS DISTINGUISHED BY ITS DISTINCTIVE FULL-HEIGHT PROFILE ON ONE SIDE THAT CREATES THE HANDLE GRIP, HERE SHOWN IN BRONZE METAL STANDARD. ON THE RIGHT, NIOBE BED. ON THE LEFT, BLOOM DESK WITH INDIRA ARMCHAIR.

\ GLASS #08

Hinged Door Wardrobes

Particolare anta aperta con profilo maniglia in Metal Standard Bronzo e anta in specchio bronzato. L'anta è dotata di serie di cerniere soft closing. Struttura interna in nobilitato Comfort Design.

/
Detail of open door with handle profile in Bronze Metal Standard and door in bronzed mirror. The door is equipped with standard soft closing hinges. Internal structure in Comfort Design melamine.

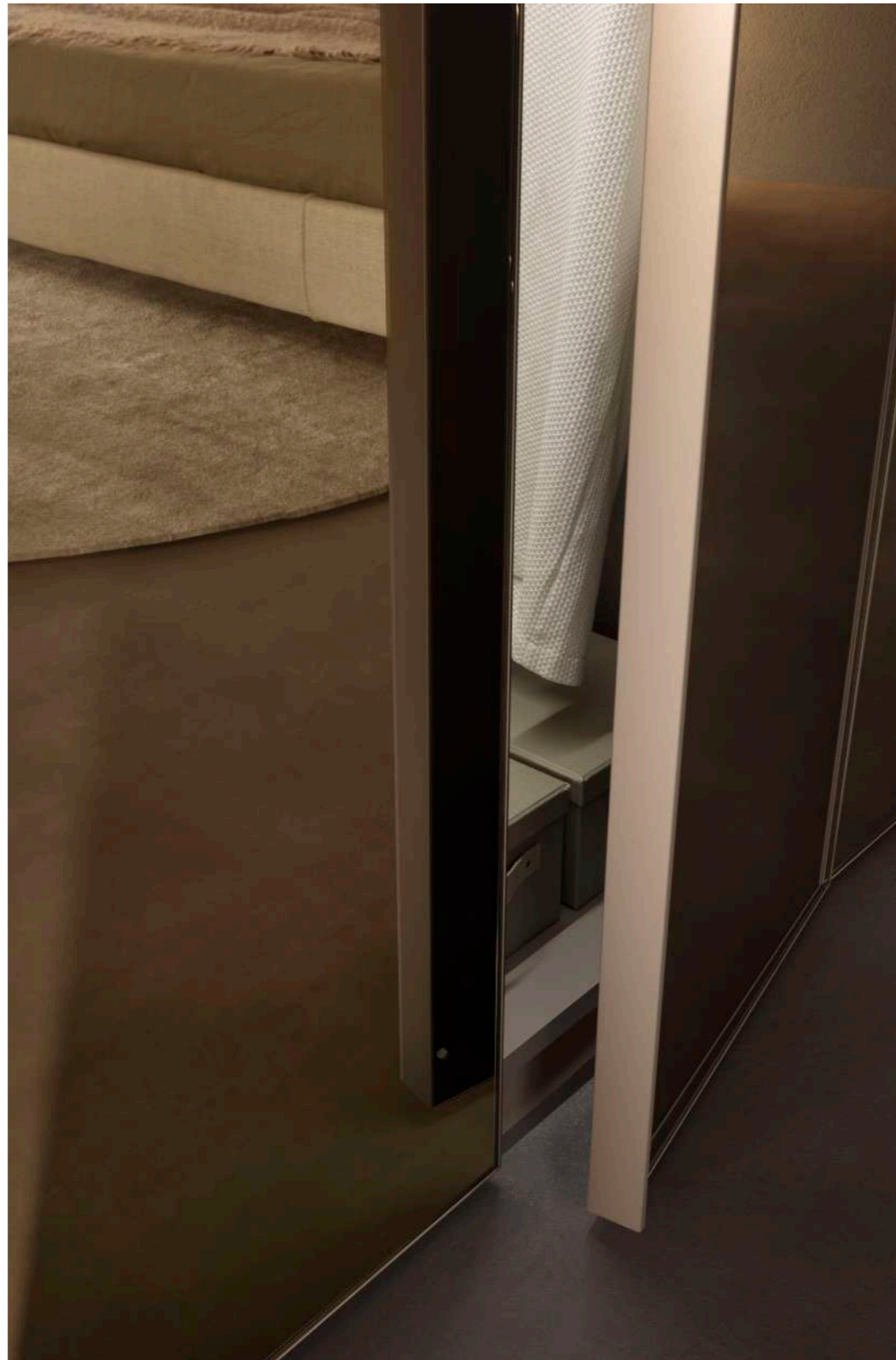

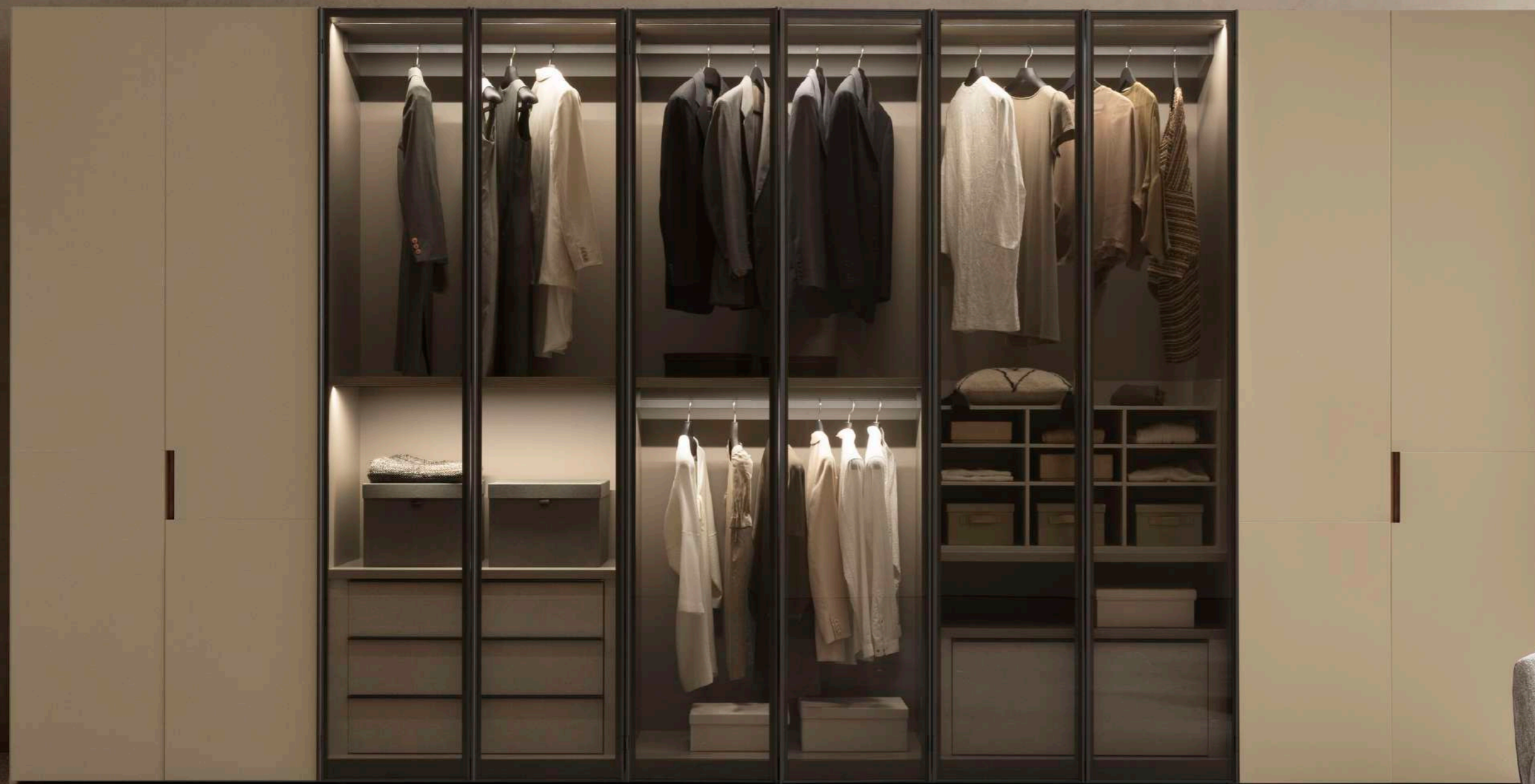

ARMADIO BATTENTE
L. 5025 H. 2544 P. 604
HINGED DOOR WARDROBE
W. 197 3/4" H. 100 1/4" D. 23 3/4"

ARMADIO BATTENTE CON MODULI DA 975 MM CON ANTE IN FINITURA LACCATO CORDA OPACO E MANIGLIA AD INCASSO NOCE CANALETTO COMBinate AD ANTE TELAIO VETRO IN VETRO TRASPARENTE GRIGIO E TELAIO IN ALLUMINIO FINITURA GRIGIO LONDRA. STRUTTURA INTERNA IN NOBILITATO COMFORT DESIGN E ATTREZZATURA COMPOSTA DA: CASSETTIERE, CESTONE E PORTA MAGLIONI. POLTRONCINA FULLER CON TAVOLINO POINT. / HINGED DOOR WARDROBE WITH 975 MM MODULES WITH DOOR IN CORDA MATT LACQUERED FINISHING AND RECESSED HANDLE IN CANALETTO WALNUT WOOD VENEER JOINED WITH GLASS FRAME DOORS IN GREY TRANSPARENT GLASS WITH ALUMINUM FRAME IN GRIGIO LONDRA FINISHING. COMFORT DESIGN MELAMINE INTERIOR STRUCTURE AND EQUIPMENT CONSISTING OF: DRAWERS, JUMBO DRAWER AND SWEATER RACK. FULLER ARMCHAIR WITH POINT COFFEE TABLE.

\ ASTIPALEA #10

Hinged Door Wardrobes

Armadio battente Astipalea in laccato opaco Corda con maniglia incassata in Noce Canaletto, Rovere Seppia o Eucalipto Dark. Le incisioni orizzontali, alternate all'altezza della maniglia, creano un motivo geometrico continuo.

Astipalea hinged door wardrobe in Corda matt lacquered with recessed handle in Canaletto Walnut, Seppia Oak or Eucalyptus Dark. Alternating horizontal carvings near the handle create a continuous geometric pattern.





ARMADIO BATTENTE
L 3625 H 2544 P 604
HINGED DOOR WARDROBE
142 ¾" H 100 ⅛" D 23 ¾"

ARMADIO BATTENTE QUERINI IN FINITURA LACCATO OPACO GRIS BEIGE E MANIGLIA QUADRATA 60X60 MM IN METAL STANDARD BRONZO. L'INSERTO ORIZZONTALE, NELLA STESSA FINITURA DELLA MANIGLIA, CREA UN DISEGNO GEOMETRICO LUNGO TUTTO L'ARMADIO. POUF DAMA IN CUIO INTRECCIATO. / QUERINI HINGED DOOR WARDROBE IN GRIS BEIGE MATT LACQUERED FINISH AND 60X60 MM SQUARE HANDLE IN BRONZE METAL STANDARD. THE HORIZONTAL INSERT, IN THE SAME FINISH AS THE HANDLE, CREATES A GEOMETRIC PATTERNING THROUGHOUT THE WARDROBE. DAMA POUF IN WOVEN SADDLE LEATHER.

\ QUERINI #12

Hinged Door Wardrobes

Particolare armadio
in finitura laccato opaco
Beige Argilla con fianchi
in tinta, poltroncina
Milo e pouf Dama.
Dettaglio presa maniglia
in finitura Metal Standard
Bronzo. L'anta è dotata
di seriedi cerniere soft
closing.

/ Detail of the wardrobe
in Beige Argilla matt
lacquered finishing with
matching sides, Milo
armchair and Dama pouf.
Handle grip detail in
Bronze Metal Standard
finish. The door is
equipped with standard
soft closing hinges.

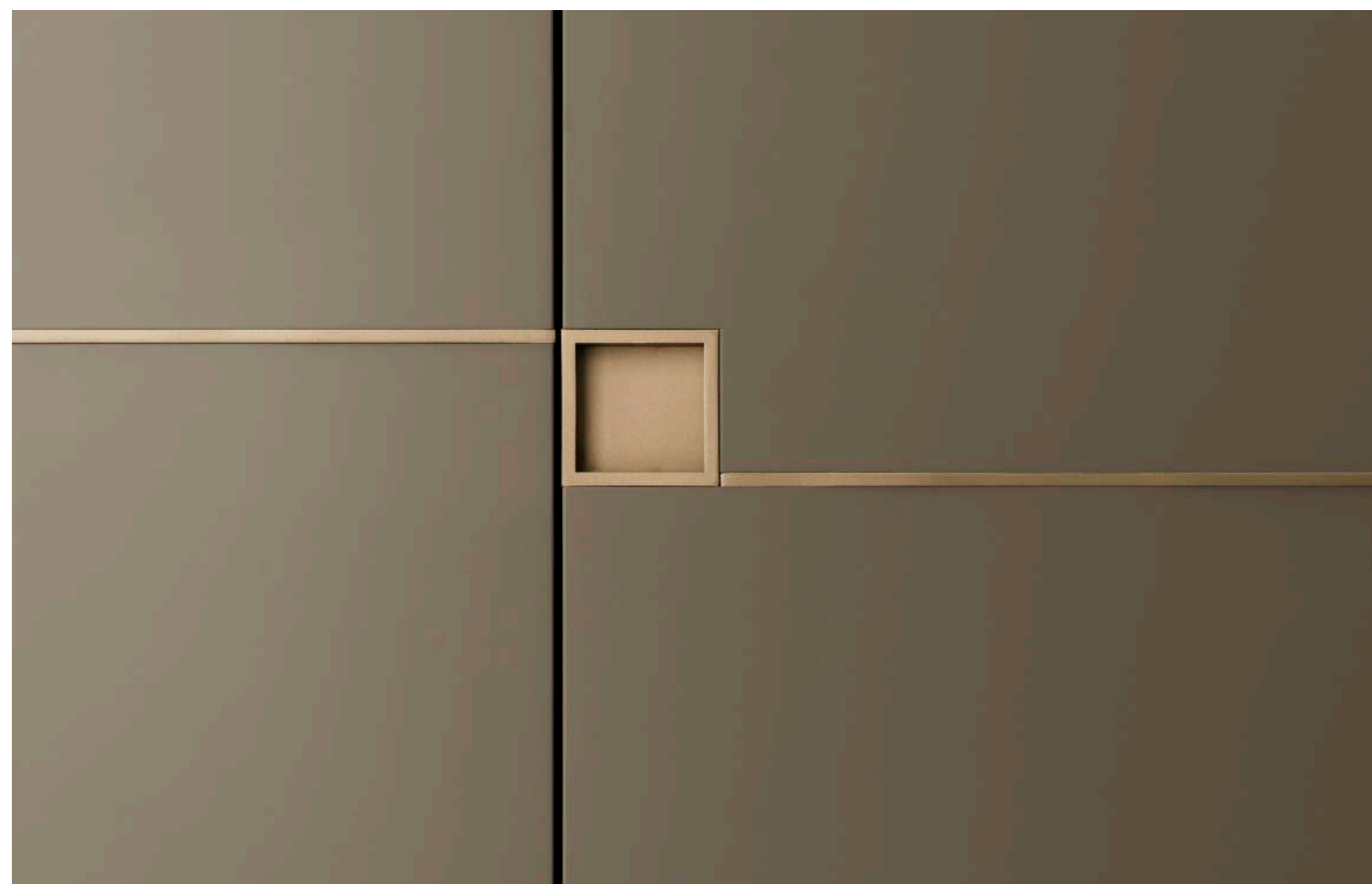



Armadio battente
Querini in versione
laccato opaco Blu
Abisso con inserto
maniglia in Metal
Standard Ottone.

Querini hinged door
wardrobe in Blu Abisso
matt lacquered version
with handle insert in
Brass Metal Standard.

Sliding Door Wardrobes / Armadi Scorrevoli



Gli armadi scorrevoli e coplanari rappresentano con le loro ante generose in larghezza, fino a 1500 mm, quanto di più bello per un armadio guardaroba si possa desiderare. Meccanismi collaudati e garantiti 10 anni certificano la loro affidabilità nel tempo. Alle 8 versioni si sono aggiunti gli scorrevoli e coplanari Sketch, Astipalea e Querini con ante da 445 mm di spessore. Le attrezzature degli armadi sono disponibili come nella versione battente.

Sliding and coplanar door wardrobes represent with their doors in width (up to 1500 mm), the most beautiful solution desired for a walk-in closet. Tested mechanisms with a 10-year guaranteed certify their reliability. Sliding and coplanar door Sketch, Astipalea and Querini with 445 mm thick doors have been added to the 8 versions. Wardrobe fittings are available as in the hinged door version.



ARMADIO SCORREVOLE
L 7250 H 2544 P604
SLIDING DOOR WARDROBE
W 285 3/8" H 100 1/8" D 23 3/4"

ARMADIO SCORREVOLE QUERINI IN FINITURA LACCATO OPACO GRIS BEIGE CON MANIGLIA INCASSATA 80X80 MM E INSERTO ORIZZONTALE IN METAL STANDARD BRONZO CHE DIVIDE ESTETICAMENTE L'ANTA IN ALTEZZA. ELEMENTI A GIORNO TRA ARMADI: SCRITTOIO FLY E RIPIANI (LISTINO '23) IN ESSENZA EUCALIPTO DARK CON BORDO MENSOLA ALLUMINIO VERNICIATO TITANIO, SCHIENA IN NOBILITATO LIVING BEIGE. SCRITTOIO FLY QUI RAPPRESENTATO CON POUF DAMA. LETTO AQUA, PANCA SIGMUND. / QUERINI SLIDING DOOR WARDROBE IN GRIS BEIGE MATT LACQUERED FINISH WITH 80X80 MM RECESSED HANDLE AND HORIZONTAL INSERT IN BRONZE METAL STANDARD THAT SPLITS THE DOOR HEIGHT. OPEN ELEMENTS BETWEEN WARDROBES: FLY DESK AND SHELVES (PRICE LIST '23) IN EUCALYPTUS DARK VENEER WITH TITANIUM PAINTED ALUMINUM SHELF EDGE, LIVING BEIGE MELAMINE BACK. FLY WRITING DESK, HERE WITH DAMA POUF. AQUA BED, SIGMUND BENCH.

\ QUERINI #14

Sliding Door Wardrobes

Sotto: dettaglio maniglia incassata con apertura scorrevole e struttura interna in nobilitato Living Beige.

A destra: attrezzatura interna composta da 3 cassetti in legno finitura Gris Beige, 1 cassetto in vetro, appendiabiti, ripiani e portapantaloni/gonne estraibili.

Below: recessed handle detail with sliding opening with interior structure in Living Beige melamine.

On the right: interior equipment composed of 3 wooden drawers in Gris Beige finish, 1 glass drawer, coat rack, shelves and removable trousers/skirt rack.





ARMADIO SCORREVOLE
L 6971 H 2544 P604
SLIDING DOOR WARDROBE
W 274 3/8" H 100 1/8" D 23 3/4"

ARMADIO SCORREVOLE SKETCH IN ESSENZA EUCALIPTO DARK, VANO A GIORNO CON SCHIENA IN LACCATO ARANCIO COTTO. COMPLEMENTI TRA ARMADI: DISPLAY A GIORNO, SEMPRE IN ESSENZA, CON RIPIANI IN VETRO TRASPARENTE E ILLUMINAZIONE A LED INTEGRATA ORIZZONTALE. L'ANTA È CARATTERIZZATA DA UN PROFILO MANIGLIA INCASSATO A TUTTA ALTEZZA IN GRIGIO LONDRA. POLTRONCINE OLIVE E POUF DAMA. / SKETCH SLIDING DOOR WARDROBE IN EUCALYPTUS DARK VENEER, OPEN COMPARTMENT WITH ARANCIO COTTO LACQUERED BACK. COMPLEMENTS BETWEEN WARDROBES: DISPLAY IN WOOD VENEER, WITH CLEAR GLASS SHELVES AND INTEGRATED HORIZONTAL LED LIGHTING. THE DOOR FEATURES A FULL-HEIGHT RECESSED HANDLE PROFILE IN GRIGIO LONDRA. OLIVE ARMCHAIRS AND DAMA POUF.

\ SKETCH #15

Sliding Door Wardrobes

Sotto: dettaglio cassetto aperto in vetro con presa maniglia in finitura brunita.

A destra: particolare armadio con ante scorrevoli aperte e attrezzatura interna composta da ripiani, appendiabiti, cassettiere; schiena in nobilitato Comfort Design. Attrezzatura tra armadi costituita da Display a giorno.

Below: open glass drawer detail with burnished finish handle gripin.

On the right: detail of sliding door wardrobe and internal equipment composed by shelves, hangers, drawers; back in Comfort Design melamine. Equipment between closets consists of a Display.





ARMADIO SCORREVOLE
L 4025 H 2544 P 604
SLIDING DOOR WARDROBE
W 158 1/2" H 100 1/4" D 23 3/4"

ARMADIO SCORREVOLE CON ANTA LISCIA
IN FINITURA LACCATO OPACO BIANCO NEVE.
/ LISCIA SLIDING DOOR WARDROBE IN
BIANCO NEVE MATT LACQUERED FINISH.

\ LISCIA #17

Sliding Door Wardrobes

Particolare apertura
anta scorrevole in
essenza Eucalipto Dark.
Struttura e attrezzatura
interna in nobilitato Comfort
Design.

/
Detail of sliding door
opening in Eucalyptus
Dark wood veneer.
Structure and interior
equipment in Comfort
Design melamine.

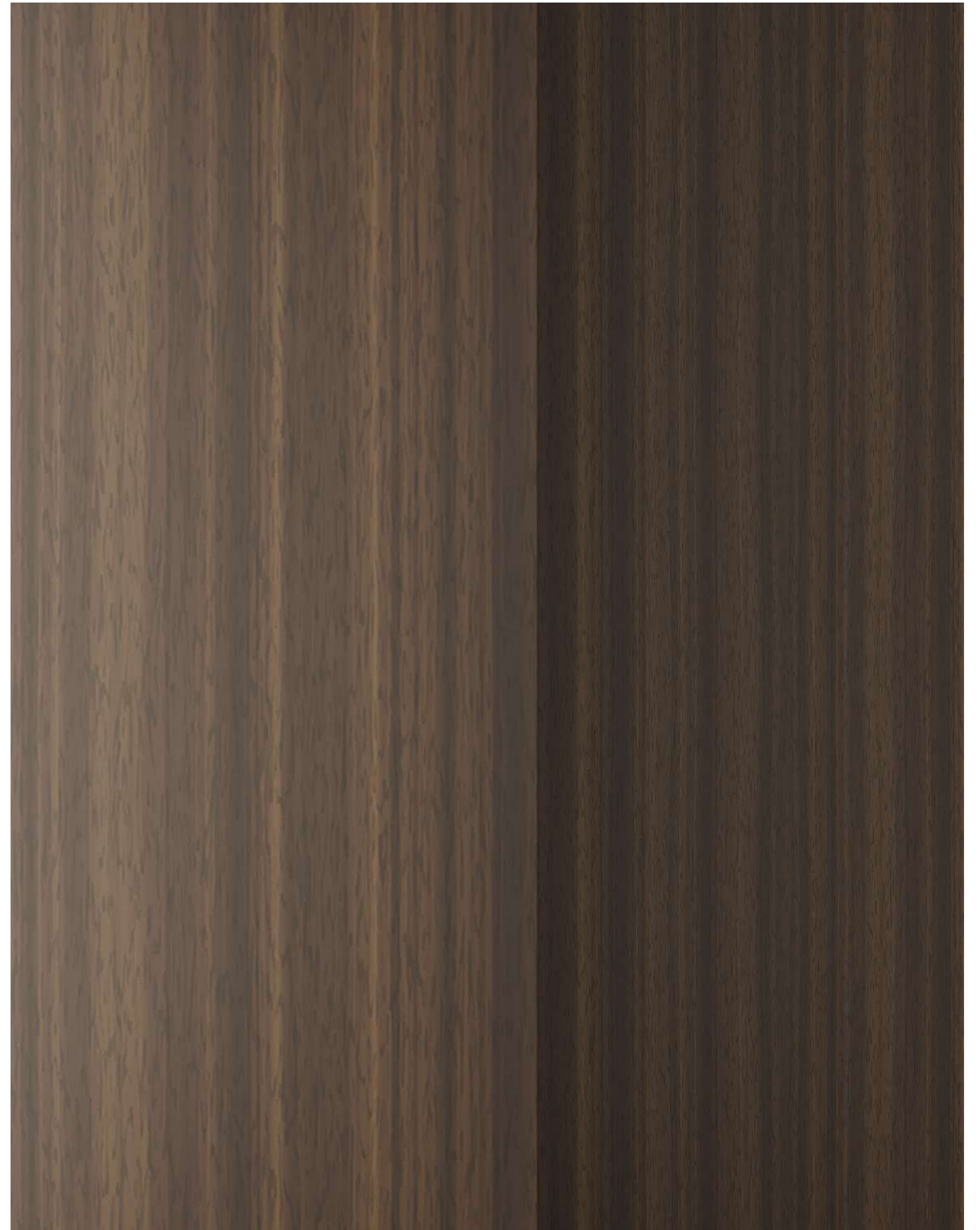



ARMADIO SCORREVOLE
L 4075 H 2544 P 604
SLIDING DOOR WARDROBE
W 160 3/8" H 100 1/8" D 23

ARMADIO SCORREVOLE TRIS IN FINITURA LACCATO OPACO BEIGE GYPSO CON MANIGLIA A SCOMPARSA SUL BORDO, FIANCHI IN TINTA. A DESTRA, PANCA DORMEUSE CON TAVOLINO DOLLY. / TRIS SLIDING DOOR WARDROBE IN BEIGE GYPSO MATT LACQUERED FINISH WITH RETRACTABLE EDGE HANDLE, SIDES IN SOLID. ON THE RIGHT, DORMEUSE BENCH WITH DOLLY COFFEE TABLE.

\ TRIS #18

Sliding Door Wardrobes

Particolare dettaglio
maniglia incassata sul
bordo in finitura cromata.
Struttura interna in
nobilitato Eucalipto.

/
Detail of recessed edge
handle in chrome finish.
Internal structure in
Eucalyptus melamine.

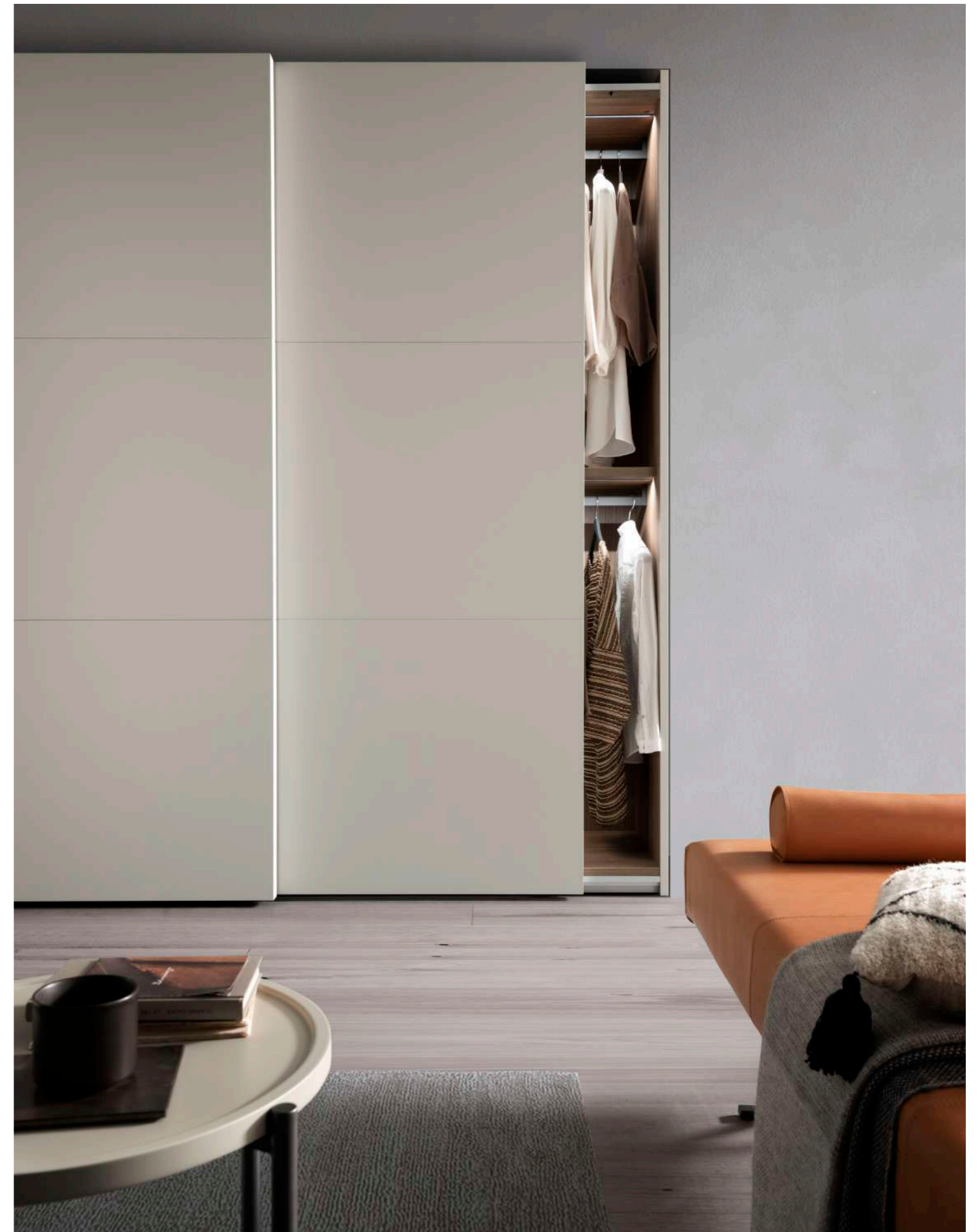



ARMADIO SCORREVOLE
L. 4075 H. 2544 P. 604
SLIDING DOOR WARDROBE
W 160 3/8" H 100 1/8" D 23 3/4"

ARMADIO SCORREVOLE TRIS TV IN FINITURA LACCATO OPACO GRIGIO POLVERE.
L'ARMADIO È COMPOSTO DA 3 PANNELLI IN MDF, POSSIBILITÀ DI ABBINARE I 3 PANNELLI
IN FINITURE DIFFERENTI SU RICHIESTA. SULLO SFONDO, POLTRONCINA BALI
/ TRIS TV SLIDING DOOR WARDROBE IN MATT GRIGIO POLVERE LACQUERED FINISH.
THE WARDROBE CONSISTS OF 3 MDF PANELS, WITH POSSIBILITY TO COMBINE THE
3 PANELS IN DIFFERENT FINISHES UPON REQUEST. IN THE BACKGROUND, BALI ARMCHAIR.

\ TRIS TV #19

Sliding Door Wardrobes

Dettaglio pannello centrale con tv.
Il pannello centrale è predisposto per il montaggio di una tv da 32"o 40" con staffa fissa, ed è dotato di un passacavo Ø 80mm. Maniglia a scomparsa sul bordo.

/
Center panel detail with TV.
The center panel is prepared for installing a 32 "or 40" TV with a fixed bracket, and is equipped with an Ø 80mm grommet. Retractable handle on the edge.

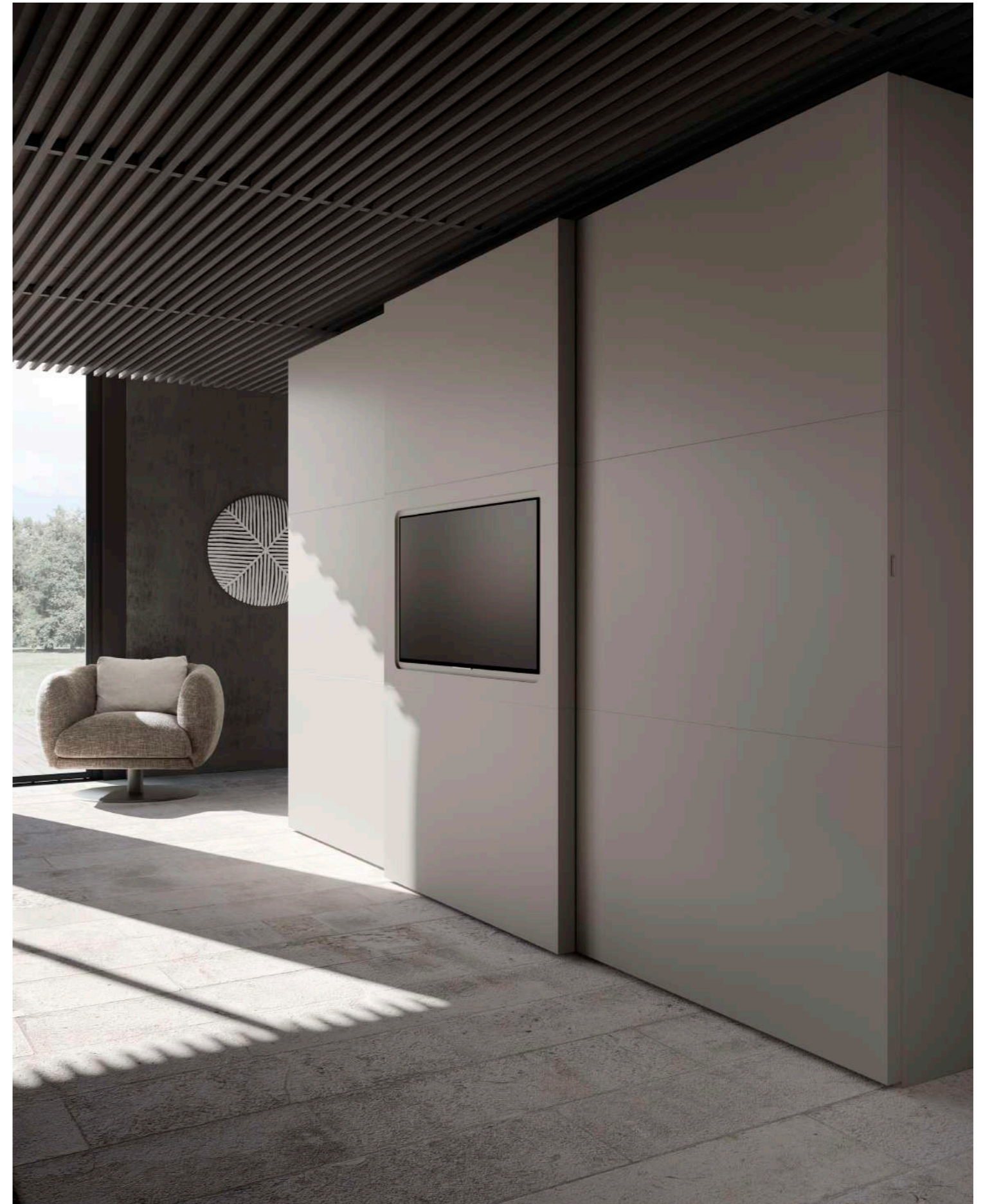

\ L12 #20

Sliding Door Wardrobes

Night program

ARMADIO SCORREVOLE
L 3025 H 2544 P 604
SLIDING DOOR WARDROBE
W 119 1/8" H 100 1/8" D 23 3/4"

ARMADIO SCORREVOLE INCASSATO A MURO CON ANTA L 12 IN VETRO SATINATO. L'ANTA L 12 SI DISTINGUE PER IL SUO PARTICOLARE PROFILO PERIMETRALE CHE CREA LA PRESA MANIGLIA, QUI IN FINITURA METAL STANDARD BRONZO. / RECESSED WALL-MOUNTED SLIDING DOOR WARDORBE WITH L 12 DOOR IN GREY SATIN GLASS. THE L 12 DOOR IS DISTINGUISHED BY ITS SPECIAL EDGE PROFILE THAT CREATES THE HANDLE GRIP, HERE IN BRONZE METAL STANDARD FINISH.

\ L12 #20

Sliding Door Wardrobes

Particolare maniglia in finitura Metal Standard Bronzo. Finitura fianchi in Grigio Polvere e struttura interna in nobilitato Comfort Design.

/
Handle detail in Bronze Metal Standard finish. Sides finishing in Grigio Polvere and interior structure in Comfort Design melamine.

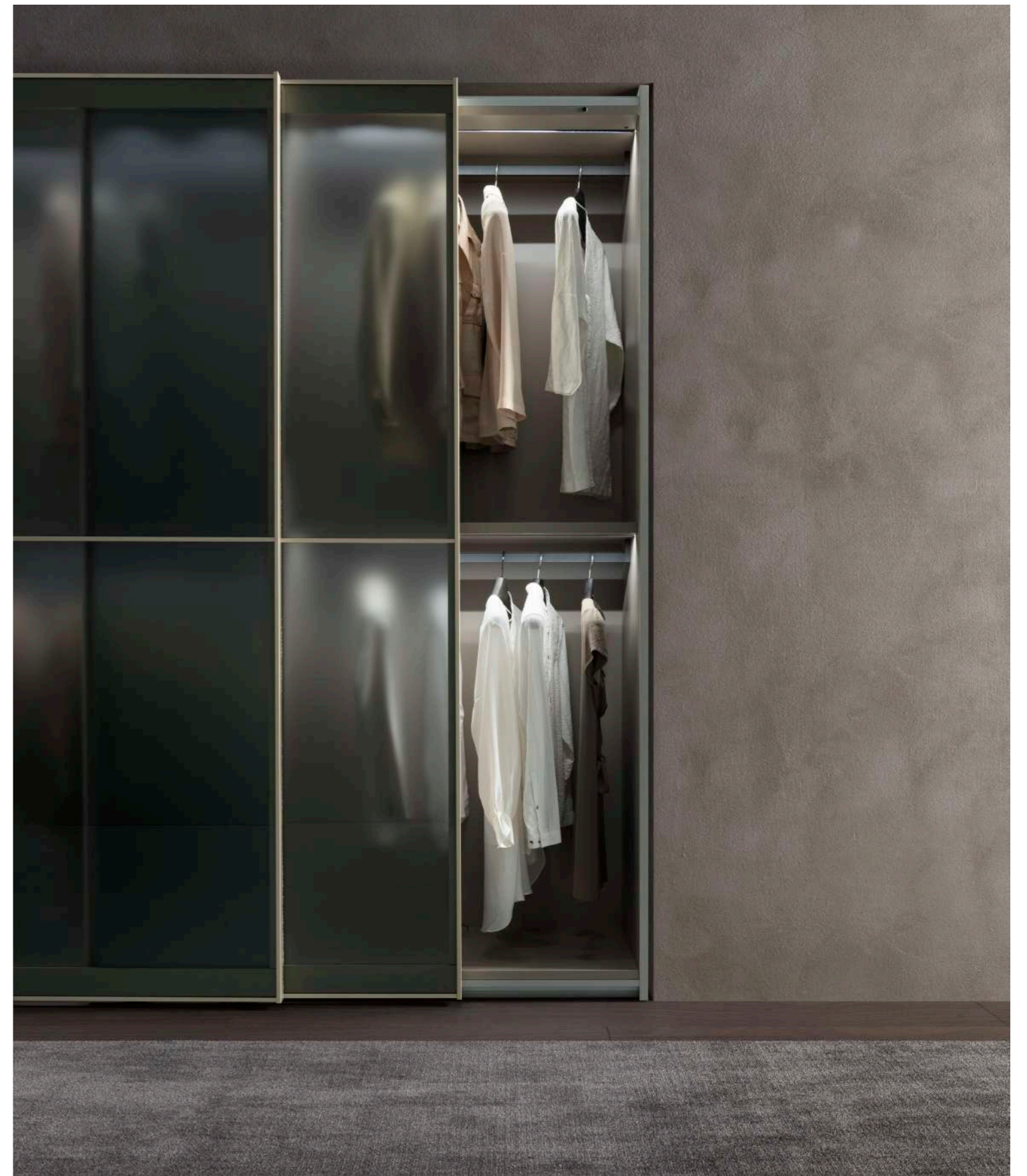
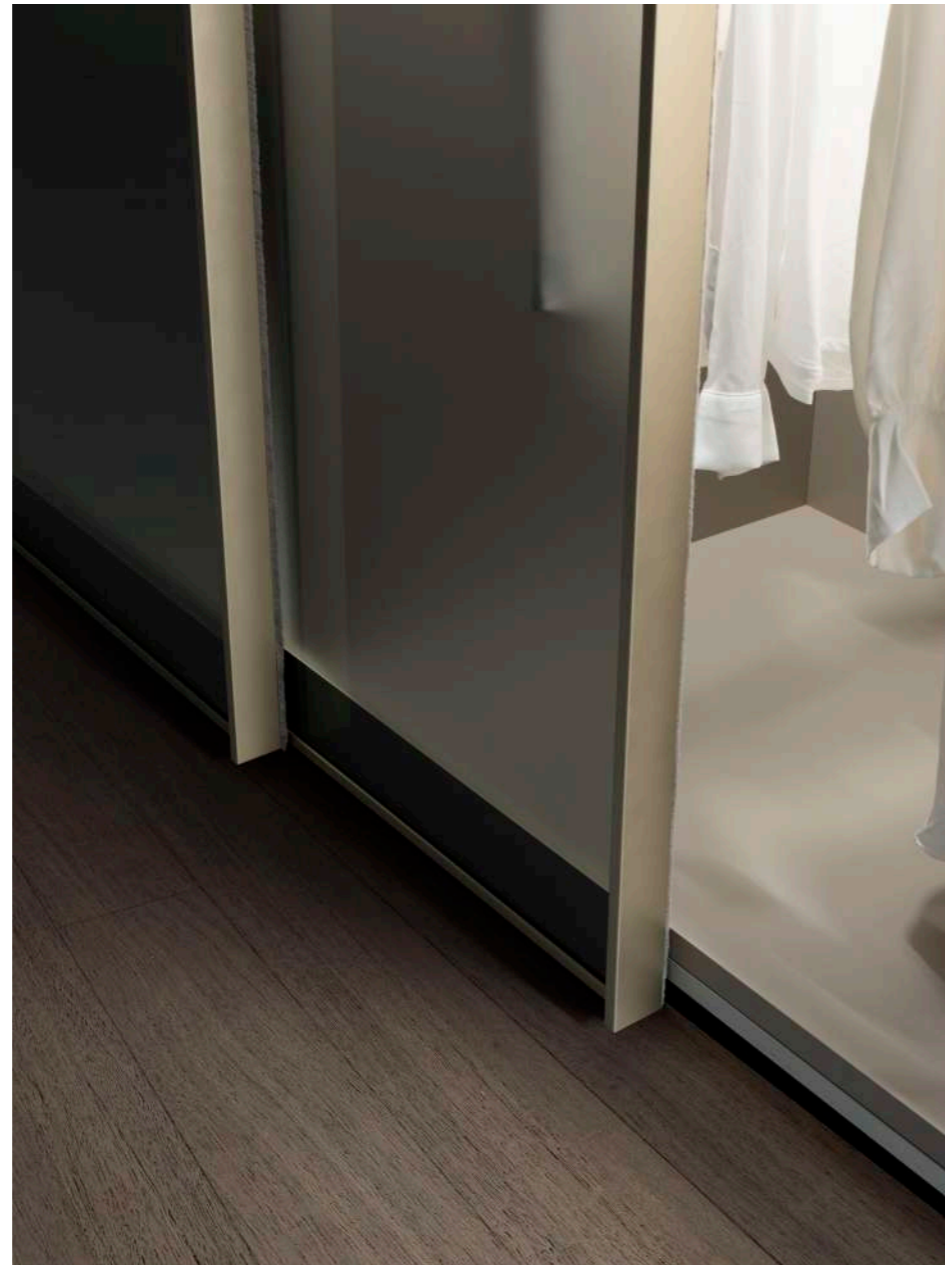



ARMADIO SCORREVOLE
L 3025 H 2544 P 604
SLIDING DOOR WARDROBE
W 119 1/8" H 100 1/8" D 23 3/4"

ARMADIO SCORREVOLE GLASS IN VETRO RETROLACCATO BIANCO CON PROFILO TELAIO IN METAL STANDARD PELTRO. PANCA CALI CON TAVOLINO DOLLY. / GLASS SLIDING DOOR WARDROBE IN WHITE BACK-LACQUERED GLASS WITH FRAME PROFILE IN PEWTER METAL STANDARD. CALI BENCH WITH DOLLY COFFEE TABLE.

\ GLASS #21

Sliding Door Wardrobes

Particolare maniglia in
finitura Metal Standard
Peltro.

L'interno dell'armadio, in
finitura nobilitato Living
Beige, è attrezzato con
aste appendiabiti.

/
Handle detail in Pewter
Metal Standard finish.
The interior of the
wardrobe, in Living
Beige melamine finish,
is equipped with hanging
rods.

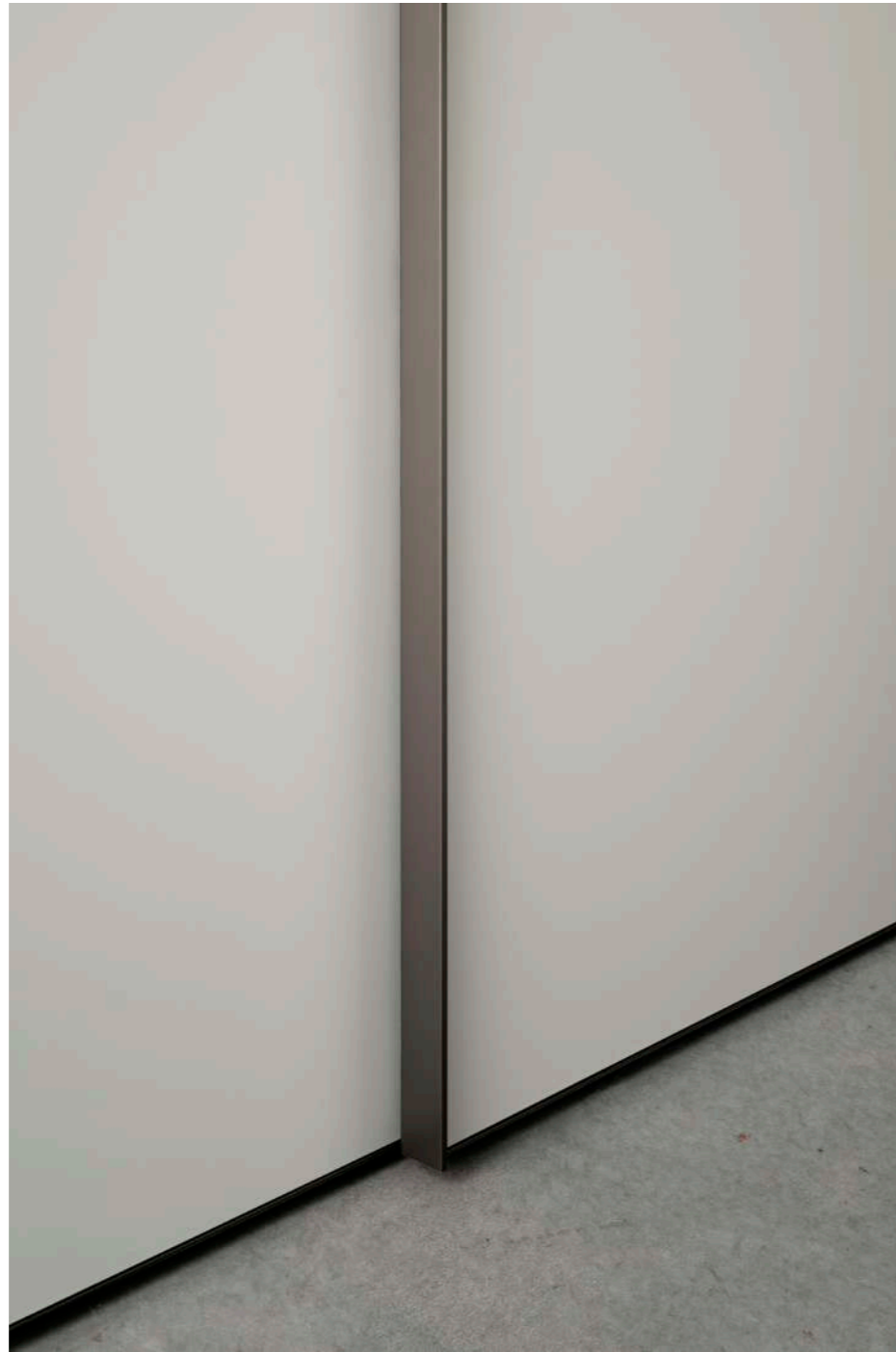



ARMADIO SCORREVOLE
L 3025 H 2544 P 604
SLIDING DOOR WARDROBE
W 119 1/8" H 100 1/8" D 23 3/4"

ARMADIO SCORREVOLE CON ANTA KALEIDOS CON VETRO RETROLACCATO BEIGE ARGILLA SATINATO E COMFORT LUCIDO. MANIGLIA INCORPORATA NEL PROFILO A TUTTA ALTEZZA IN FINITURA BEIGE ARGILLA. POSSIBILITÀ DI REALIZZARE L'ANTA FINO A 3 COLORAZIONI DIVERSE. / SLIDING DOOR WARDROBE WITH KALEIDOS DOOR IN SATIN BEIGE ARGILLA AND GLOSSY COMFORT BACKLACQUERED GLASS. HANDLE INCORPORATED INTO THE FULL-HEIGHT PROFILE IN BEIGE ARGILLA FINISHING. AVAILABLE UP TO 3 DIFFERENT COLOR COMBINATIONS FOR EACH DOOR.

\ KALEIDOS #22

Sliding Door Wardrobes

Particolare presa maniglia
in tinta con il colore
dell'anta Beige Argilla
opaco.

/
Handle grip detail matching
the door color in Beige
Argilla matt finish.

Night program



ARMADIO COMPLANARE
L 5025 H 2544 P 604
COPLANAR WARDROBE
W 197 7/8" H 100 1/8" D 23 3/4"

ARMADIO COMPLANARE ASTIPALEA IN FINITURA LACCATO GRIGIO POLVERE. ELEMENTI A GIORNO TRA ARMADI: MENSOLE E DISPLAY SCRITTOIO CON ANTA A RIBALTA IN ESSENZA ROVERE LINCE. POUF LANDSCAPE, POUF DAMA AL CENTRO E POLTRONE MIMOSA CON COFFEE TABLE KONA. / ASTIPALEA COPLANAR WARDROBE IN GRIGIO POLVERE LACQUERED FINISHING. OPEN ELEMENTS BETWEEN WARDROBES: SHELVES AND WRITING DISPLAY WITH DROP-DOWN DOOR IN LINCE OAK VENEER. LANDSCAPE POUF, DAMA POUF IN THE CENTER AND MIMOSA ARMCHAIRS WITH KONA COFFEE TABLE.

Coplanar Wardrobe

Dettaglio ante aperte con maniglia incassata in Metal Standard Peltro o essenza, e attrezzatura interna composta da: mensole con luce led integrata, appendiabiti, portapantaloni/gonne estraibile, 3 cassetti in finitura Grigio Polvere e 1 cassetto in vetro. Struttura interna in nobilitato Comfort Design. Complementi tra armadi: mensole e Display scrittoio in Rovere Lince. Qui rappresentata con pouf Landscape.

/ Open door detail with recessed handle in Pewter Metal Standard or wood veneer and interior equipment consisting of: shelves with integrated LED light, coat rack, removable trouser/skirt rack, 3 drawers chest in matt Grigio Polvere lacquered finish and 1 glass drawer. Interior structure in Comfort Design melamine. Complements between wardrobes: shelves and Writing Display in Lince Oak. Here suggested with Landscape pouf.





ARMADIO COMPLANARE
L 2425 H 2544 P 604
COPLANAR WARDROBE
W 119 1/8" H 100 1/8" D 23 3/4"

ARMADI COMPLANARI IN FINITURA BIANCO GIGLIO OPACO CON MANIGLIA INCASSATA SUL FIANCO INTERNO IN FINITURA METAL STANDARD OTTONE. FIANCHI STRUTTURA IN TINTA BIANCO GIGLIO OPACO. MADIA RHO E POUF PILAR. / COPLANAR DOOR WARDROBES IN BIANCO GIGLIO MATT LACQUERED WITH RECESSED HANDLE ON THE INNER SIDE IN BRASS METAL STANDARD FINISH. STRUCTURE SIDES IN MATT BIANCO GIGLIO FINISH. RHO SIDEBBOARD AND PILAR POUF.

\ TAU #25

Coplanar Wardrobe

Versione Tau complanare
in finitura Rovere Seppia.
Fianchi in Rovere Seppia
e struttura interna in
nobilitato Tay.
Particolare presa maniglia
in finitura Metal Standard
Peltro.

/
Tau coplanar version
in Seppia Oak finish.
Sides in Seppia Oak
wood veneer and internal
structure in Tay melamine.
Handle grip detail in Pewter
Metal Standard finishing.



Walk-in Closets
/ Cabine Armadio



Esempi di cabina armadio con ante battenti e scorrevoli per conservare e proteggere gli abiti dalla polvere, un'area a giorno con TecnoPolis Free o una boiserie Varius per un facile accesso alle cassettiere e ripiani o agli abiti da giorno. Leggerezza e praticità adatte per gli spazi più piccoli.

Examples of walk-in closets with hinged and sliding doors to store and protect clothes from dust, TecnoPolis Free open storage cabinet or Varius boiserie with easy access to chests of drawers and shelves or day clothes. Lightness and practicality suitable for small spaces.



TECNOPOLIS FREE METAL

L 5276 H 2544 P 604
W 207 3/4" H 100 1/8" D 23 3/4"

NAOS

L 3636 H 2544 P 604
W 143 1/8" H 100 1/8" D 23 3/4"

ARMADIO TECNOPOLIS FREE METAL CONFIGURAZIONE CABINA ARMADIO CON VANI A GIORNO ATTREZZATI CON CASSETTIERE, PORTAPANTALONI ESTRAIBILE, RIPIANI IN VETRO CON LUCE LED INTEGRATA E APPENDIABITI. STRUTTURA CON DIVISORI METALLICI PASSANTI IN GRIGIO LONDRA, SCHIENA BOISERIE IN ESSENZA ROVERE LINCE. SULLA DESTRA, NAOS ARMADIO BATTENTE CON ANTE IN PELLE BASIC. / TECNOPOLIS FREE METAL WALK-IN CLOSET CONFIGURATION WITH OPEN COMPARTMENTS EQUIPPED WITH DRAWERS, PULL-OUT TROUSER RACK, GLASS SHELVES WITH INTEGRATED LED LIGHT AND COAT RACK. STRUCTURE WITH METAL THROUGH PARTITIONS IN GRIGIO LONDRA, BOISERIE BACK IN LINCE OAK VENEER. ON THE RIGHT, NAOS HINGED WARDROBE WITH BASIC LEATHER DOORS.

Walk-in Closet and Hinged Door Wardrobe

Particolare attrezzatura interna con fianchi metallici passanti in vetro. Ripiani in vetro e ripiani inclinati portascarpe, cassettoni con griglia porta oggetti e portapantaloni estraibile.

Special interior equipment with glass-through metal sides. Glass shelves and slanted shoe shelves, drawer unit with storage grid and pull-out trouser rack.





**TECNOPOLIS FREE
METAL-WOOD**
L 6150 H 3175 P 604
W 242 1/8" H 125" D 23 3/4"

ARMADIO TECNOPOLIS FREE METAL WOOD CONFIGURAZIONE CABINA ARMADIO CON VANI A GIORNO ATTREZZATI CON STRUTTURA E FIANCHI IN NOBILITATO EUCALIPTO, FIANCHI PASSANTI IN METALLO CON ILLUMINAZIONE LED VERTICALE. / TECNOPOLIS FREE METAL WOOD WALK-IN CLOSET CONFIGURATION WITH OPEN COMPARTMENTS EQUIPPED WITH EUCALYPTUS MELAMINE FRAME AND SIDES, METAL SIDES WITH VERTICAL LED LIGHTING.

Walk-in Closet

Cabina armadio ad angolo con attrezzatura interna con divisori in metallo e fianchi terminali in Eucalipto. Ripiani in vetro e legno, ripiani inclinati portascarpe, cassettiera, portapantaloni estraibile e appendiabiti.

/ Corner walk-in closet with internal equipment, metal passing frame dividers and Eucalyptus end sides. Glass and wood shelves, inclined shoe shelves, chest of drawers, pull-out trouser rack and coat rack.





TECNOPOLIS FREE WOOD
L 6150 H 3175 P 604
W 242 1/8" H 125" D 23 3/4"

ARMADIO TECNOPOLIS FREE WOOD CONFIGURAZIONE CABINA ARMADIO CON VANI A GIORNO ATTREZZATI, CASSETTIERE, FIANCHI E SCHIENE IN ROVERE SEPIA. / TECNOPOLIS FREE WOOD WALK-IN CLOSET CONFIGURATION WITH EQUIPPED OPEN COMPARTMENTS, DRAWERS, SIDES AND BACKS IN SEPIA OAK FINISH.



Cabina armadio con attrezzatura interna e fianchi il legno con illuminazione led verticale.
Struttura interna formata da: ripiani in legno, in vetro e ripiani inclinati portascarpe, cassettera, portapantaloni estraibile e appendiabiti.
/ Walk-in closet with internal equipment and wooden sides with vertical led lighting.
Internal structure composed by: wooden, glass and inclined shoe shelves, chest of drawers, pull-out trouser rack and coat rack.



CABINA ARMADIO
L 5336 H 2544 P 604
WALK-IN CLOSET
W 210 1/8" H 100 1/4" D 23 3/4"

CABINA VARIUS COMPOSTA DA ANTE SCORREVOLI LISCIA PIÙ ANTA BATTENTE LISCIA IN FINITURA CORDA. BOISERIE VARIUS CON SISTEMA DI ATTREZZATURA ESTERNA SENZA ANTE FORMATA DA RIPIANI E CASSETTIERE. POUF DAMA E POLTRONCINE FULLER. / VARIUS WALK-IN CLOSET COMPOSED BY SLIDING AND HINGED DOORS IN CORDA LAQUERED FINISHING. VARIUS BOISERIE WITH EXTERNAL EQUIPMENT SYSTEM WITHOUT DOORS COMPOSED BY SHELVES AND DRAWERS. DAMA POUF AND FULLER ARMCHAIRS.

Particolare cabina Varius:
schienale boiserie
in nobilitato Eucalipto,
pedana a terra, cassettiere
sospese, appendiabiti
e ripiani con luce led
integrata in finitura laccato
opaco Corda. Struttura
interna armadio con anta
liscia scorrevole e battente
in nobilitato Living Beige.

Varius walk-in closet
detail: back paneling in
Eucalyptus melamine, floor
platform, hanging drawers,
hangers and shelves
with integrated LED light
in Corda matt lacquered
finishing. Closet interior
structure with sliding and
hinged doors Liscia
in Living Beige melamine.



Il taglio a mansarda consente un adattamento perfetto a qualsiasi sottotetto senza sprecarne spazio. Armadio battente, qui rappresentato, insieme allo scrittoio e tavolino Relevé, sedia Indira e poltroncina Fuller.

The oblique cut allows perfect adaptation to any attic without wasting space. Hinged door wardrobe, shown here, along with the Relevé desk and coffee table, Indira chair and Fuller armchair.



\ MANSARDA #30

Special Solutions

Particolare anta aperta
in laccato opaco Bianco
Giglio con maniglia Lipsi
color brunito.
Fianchi in laccato opaco
Bianco Giglio. Struttura
e attrezzatura interna in
nobilitato Living Beige.

/
Detail open door in Bianco
Giglio matt lacquered with
burnished Lipsi handle.
Sides in Bianco Giglio matt
lacquered. Structure and
interior fittings in Living
Beige melamine.

Night program



Beds / Letti



Una ricca collezione di letti imbottiti accompagnati da 2 letti in legno: letto Plana in laccato opaco o Metal Standard e letto Aqua in laccato opaco o essenza. Le dimensioni dei letti accolgono 6 tipi di materasso da 100 / 120 / 160 / 180 / 153 (Queen size) / 194 (King size) cm. Ampia è la gamma disponibile di tessuti, pelli e legni.

A rich collection of upholstered beds here shown by 2 wooden beds: Plana bed in matt lacquered or Metal Standard and Aqua bed in matt lacquered or veneer. Beds can accommodate 6 types of mattresses 100 / 120 / 160 / 180 / 153 (Queen size) / 194 (King size) cm. A wide range of fabrics, leathers and woods are available.



LETTO WING
L 2800 P 2225 H 917
WING BED
W 110 1/4" D 87 3/8" H 36 1/8"

LETTO CON STRUTTURA SOSPESA RIVESTITA IN TESSUTO CON CORNICE PERIMETRALE IMBOTTITA E BOISERIE RETROILLUMINATA OPZIONALE. COMODINI SOSPESI.
COMO INSIDE.
/ BED WITH SUSPENDED FRAME COVERED IN FABRIC WITH UPHOLSTERED PERIMETRICAL FRAME AND OPTIONAL BACKLIT BOISERIE. SUSPENDED NIGHTSTANDS.
INSIDE DRAWER UNIT.

Letto con struttura sospesa rivestita in tessuto PLANET ENZIMI, cornice perimetrale imbottita dello stesso tessuto e completa di rete autoportante inclusa. Basamento in metacrilato con illuminazione led. Comodini sospesi in finitura Noce Canaletto. Testiera boiserie retroilluminata opzionale in laccato opaco Beige Argilla.

Bed with upholstered suspended frame in PLANET ENZIMI fabric, upholstered perimetral frame in the same fabric and with self-supporting bed base included. Methacrylate base with led lighting. Optional suspended nightstands in Canaletto Walnut finishing. Backlit boiserie headboard in Beige Argilla matt lacquered.

Technical info page 220





LETTO FEZ
L 1930 P 2395 H 970
FEZ BED
W 76" D 94 1/4" H 38 1/8"

LETTO FEZ.
COMODINI E COMÒ SIGMA, POLTRONA MIMOSA,
PANCA SIGMUND, ARMADIO TRIS TV. / FEZ BED.
SIGMA NIGHTSTANDS AND DRAWERS, MIMOSA ARMCHAIR,
SIGMUND BENCH, TRIS TV WARDROBE.

La testata imbottita reclinata è pensata per dare un elevato livello di comfort, rendendo il letto piacevole anche nei momenti di lettura. Il letto viene proposto con giroletto essenziale in tessuto YUCATAN sostenuto da piedini metallici. Qui suggerito con comodino Sibari.

/The reclined upholstered headboard is designed to give a high level of comfort, making the bed enjoyable even during reading moments. The bed is offered with essential bed frame in YUCATAN fabric supported by metal feet. Here suggested with Sibari nightstand.



Technical info page 220





LETTO DOLLY LARA
L 2200 P 2250 H 1120
DOLLY LARA BED
W 86 5/8" D 88 5/8" H 44 1/8"

LETTO DOLLY LARA.
COMODINO DOLLY, POUF PILAR.
/ DOLLY LARA BED.
DOLLY NIGHTSTAND, PILAR POUF.



\ DOLLY LARA #34

Beds

Un morbido letto avvolgente rivisitato in chiave contemporanea che offre una sensazione di intimità. La testata in legno curvato è rivestita in tessuto PLANET ENZIMI come il giroletto sospeso. Particolare testiera con cuciture verticali, piedino in Metal Standard Peltro e comodino Dolly in tinta Arancio Cotto che crea un total look.

/ A soft wraparound bed revisited in a contemporary key that offers a cozy feel. The curved wooden headboard is upholstered in PLANET ENZIMI fabric as the suspended bed frame. Particular headboard with vertical stitching, foot in Pewter Metal Standard and Dolly nightstand in Arancio Cotto that creates a total look. and drawers.

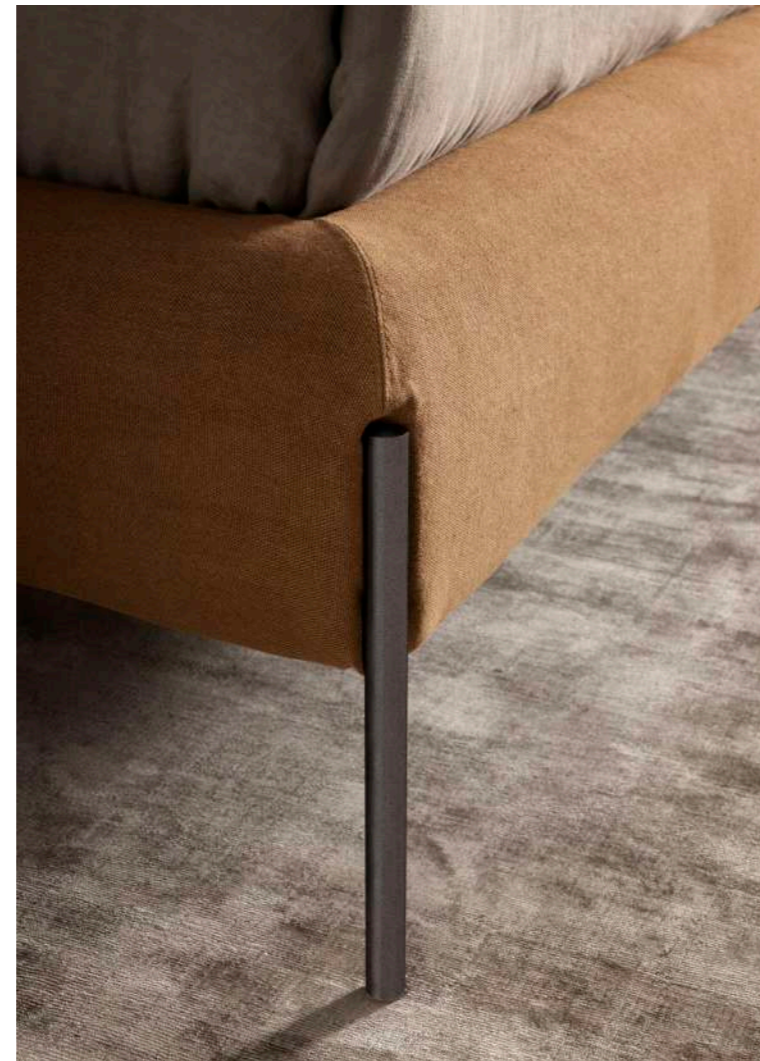

Technical info page 221



\ DOLLY ROSE #35

Bed group

Night program

LETTO DOLLY ROSE
L 2400 P 2250 H 1070
DOLLY ROSE BED
W 94 ½" D 88 ¾" H 42 ½"

LETTO DOLLY ROSE, COMO
E COMODINO DOLLY, POLTRONCINA
FULLER, COMPOSIZIONE INCLINART
CON ROUF PILAR. / DOLLY ROSE BED,
DOLLY DRAWER AND NIGHTSTAND,
FULLER ARMCHAIR, INCLINART
COMPOSITION WITH PILAR POUF.

\ DOLLY ROSE #35

Beds

Letto dalle linee essenziali, morbide ed eleganti. Caratterizzato da una lunga testiera lineare con cucitura orizzontale. Particolare dettaglio della testata in tessuto verde VOLT con cordino in ecopelle TIME che ne percorre l'intero perimetro.

Bed with essential, soft and elegant lines. Characterized by a long linear headboard with horizontal stitching. Detail of the headboard in green VOLT fabric with TIME eco leather cord running around the whole perimeter.

Technical info page 221



\ NIOBE #36

Beds

Night program



LETTO NIOBE
L 2736 P 2210 H 1162
NIOBE BED
W 107 3/4" D 87" H 45 3/4"

LETTO NIOBE.
COMODINO WING, LAMPADA
DA TERRA LUCIGNOLO, POUF
LANDSCAPE UP / NIOBE BED.
WING NIGHTSTAND, LUCIGNOLO
FLOOR LAMP, LANDSCAPE UP POUF.

\ NIOBE #36

Beds

Niobe, il letto dalla testiera importante e con forte personalità. Particolare testiera, qui in versione asimmetrica, caratterizzata da una serie di pannelli imbottiti in tessuto BALTIMORA che, alternando dimensioni e cuciture, disegnano diverse forme.

/ Niobe, the bed with an important headboard and strong personality. Particular headboard, here in asymmetrical version, characterized by a series of upholstered panels in BALTIMORA fabric that, alternating sizes and seams, draw different shapes.

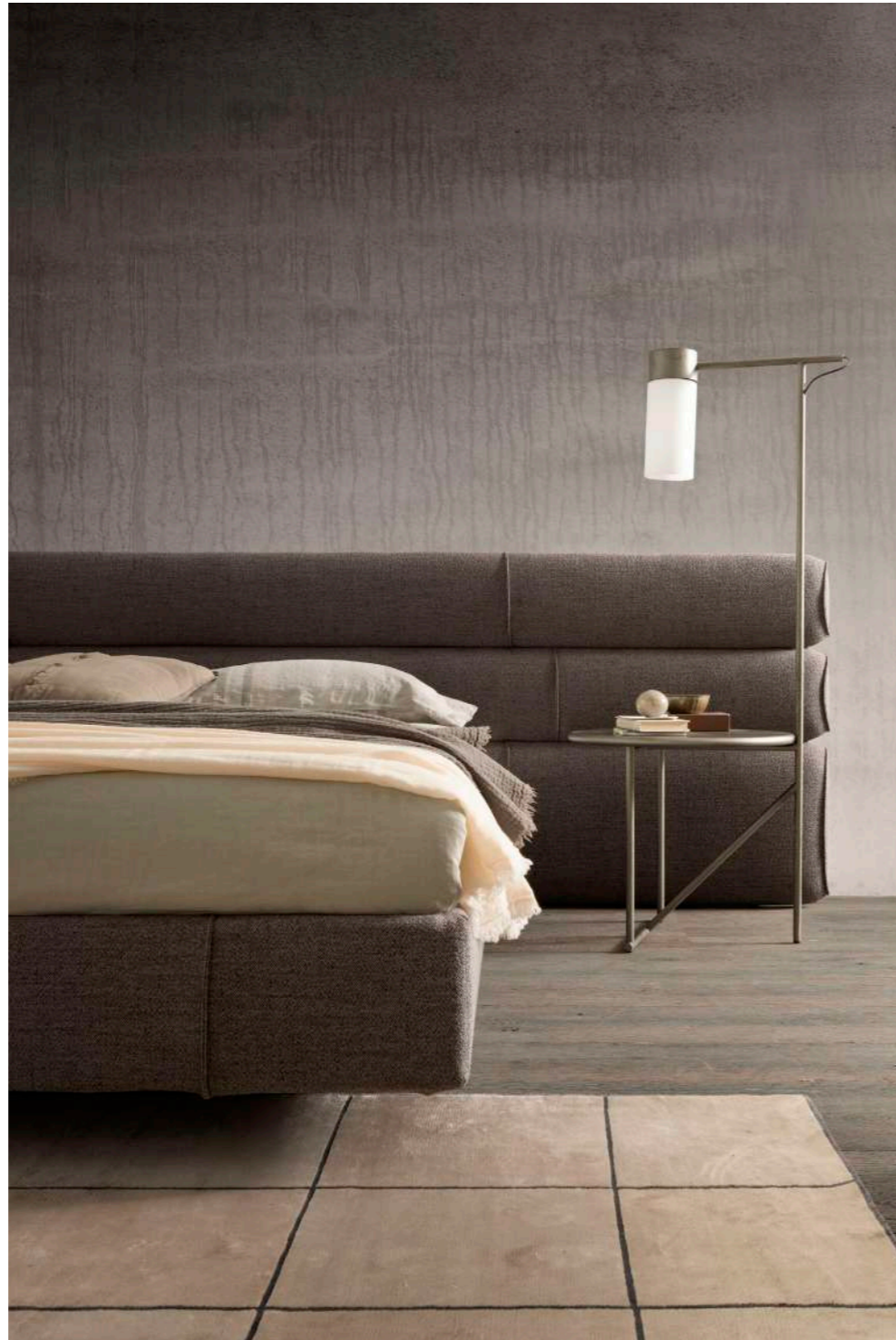



LETTO CALI
L. 1930 P. 2395 H. 970
CALI BED
W. 76" D. 94 1/4" H. 38 1/8"

LETTO CALI.
COMODINO SIBARI, TAVOLINO MW.
/ CALI BED.
SIBARI NIGHTSTAND, MW COFFEE TABLE.

La testiera è composta da due abbondanti e morbidi cuscini adagiati su un elemento di sostegno mentre il ring si appoggia a terra su sottili piedini in metallo, offrendo una suggestione di assoluta leggerezza. Letto monocolore rivestito in pelle con piedini cilindrici in laccato Metal Standard Peltro.

/ The headboard consists of two large, soft cushions laying on a support element while the ring rests on the ground on thin metal feet, offering a suggestion of absolute lightness. Single-colour bed upholstered in leather with cylindrical feet in Pewter Metal Standard.





LETTO PLANA
L 1960 P 2250 H 938
PLANA BED
W 77 1/4" D 88 5/8" H 36 7/8"

LETTO PLANA IN LEGNO LACCATO OPACO O METAL STD.
TAVOLINO POINT, CONTENITORE NOTTE INSIDE, POUF
DAMA, POLTRONCINA FULLER. / PLANA BED IN MATT
LACQUERED OR METAL STD. POINT SIDE TABLE, INSIDE
NIGHT STORAGE UNIT, DAMA POUF, FULLER ARMCHAIR.

\ PLANA #38

Beds

Lineare, liscio, essenziale, Plana è l'incontro semplice di base e testiera, due superfici che si intersecano definendo graficamente una struttura estremamente minimal in laccato opaco Grigio Antracite sorretto da un piede in metacrilato. Particolare testata inclinata che lo rende unico grazie alle sue forme essenziali.

/ Linear, smooth, essential, Plana is the simple meeting between base and headboard, two surfaces that intersect with each other, graphically defining an extremely minimal structure in Grigio Antracite matt lacquered supported by a methacrylate foot. Particular inclined headboard that makes it unique thanks to its essential shapes.

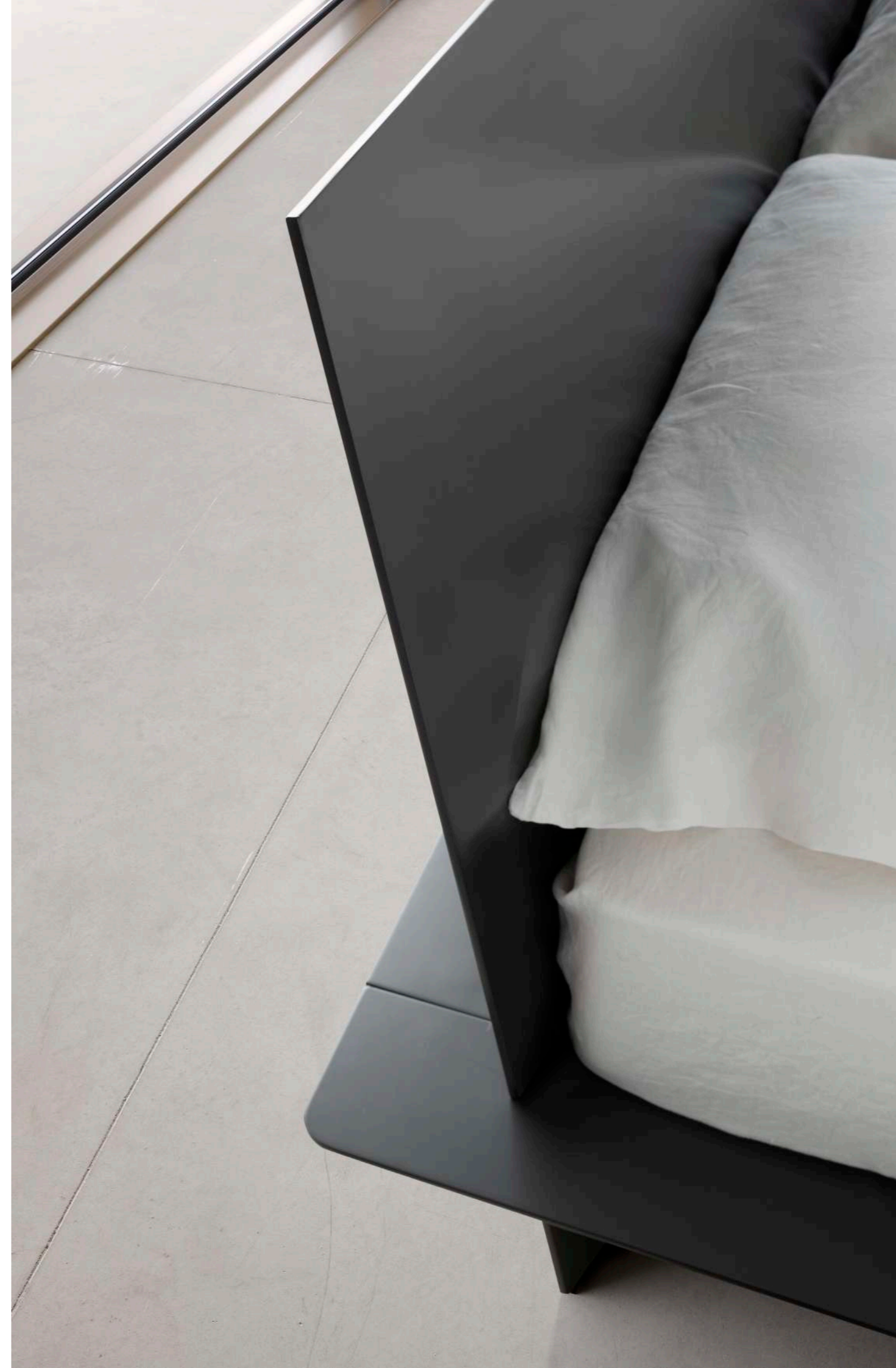

\ RELEVÈ #39

Beds

Night program



LETTO RELEVÈ
L 1968 P 2168 H 885
RELEVÈ BED
W 66 3/8" D 85 3/8" H 34 7/8"

LETTO RELEVÈ
POUF PILAR.
/ RELEVÈ BED.
PILAR POUF.

\ RELEVÈ #39

Beds

Letto in legno dall'animo garbato, caratterizzato da forme minimal e dinamiche, si distingue per la cura dei dettagli nel disegno e nella manifattura. Testiere rivestita in pelle SOFT con struttura in essenza Noce Canaletto. Panca Relevè con finiture abbinata al letto.

/ A wooden bed with a graceful spirit, characterized by minimal and dynamic forms, it stands out for its attention to detail in design and workmanship. Upholstered headboard in SOFT leather with Canaletto Walnut veneer structure. Relevè bench with finishings matching to the bed.





LETTO MEETING UP
L 1974 P 2240 H 1100
MEETING UP BED
W 77 ¼" D 88 ½" H 43 ¼"

LETTO MEETING UP
POUF PILAR.
/ MEETING UP BED.
PILAR POUF.

\ MEETING UP #40

Beds

Letto imbottito di cui l'elemento distintivo è la testiera, costituita da due parti trapezoidali disponibili in versione monocolore o bicolore. Qui, particolare testata letto e giroletto in pelle SOFT e tessuto grigio PLANET ENZIMI. Pouf Pilar in pelle abbinato.

/ Upholstered bed of which the distinctive element is the headboard, consisting of two trapezoidal parts available in single or two colors versions. Here, detail of bed headboard and bed frame in SOFT leather and PLANET ENZIMI gray fabric. Pilar pouf in leather matching with the bed one.



\ AQUA #41

Beds

Night program



LETTO AQUA
L 3080 P 2344 H 830
AQUA BED
W 121 ¼" D 92 ¼" H 32 ⅝"

LETTO AQUA IN ESSENZA
ROVERE SEPPIA.
/ AQUA BED IN SEPPIA
OAK WOOD VENEER.

Letto disegnato da un'unica superficie in multistrato curvato, che ricorda il movimento di un'onda. Gambe in metacrilato ulteriormente enfatizzate dal sistema di illuminazione LED.

Particolare dettaglio della testata in essenza Rovere Tabacco con aggiunta di vassoi estraibili con la funzione di piano d'appoggio e contenimento essenziale. Supporto in metacrilato sul retro dei comodini.

/
A bed designed from a single surface of curved plywood, resembling the movement of a wave. Methacrylate legs further emphasized by the LED lighting system.
Detail of the headboard in Tobacco Oak wood veneer with the addition of pull-out trays with the function of an essential shelf and storage. Methacrylate support on the back of the nightstands.





LETTO ZERO
L 2700 P 2570 H 937
ZERO BED
W 106 ¼" D 101 ⅛" H 36 ⅞"

LETTO ZERO. POLTRONCINA
FULLER, TAVOLINO POINT.
/ ZERO BED. FULLER
ARMCHAIR, POINT SIDE TABLE.

Letto nato dalla combinazione di due forme pure come cerchio e quadrato, diventa protagonista in qualsiasi ambiente venga inserito. La sua particolare forma rotonda lo rende unico e dal design originale. Letto realizzato in pannelli di particelle rivestito in pelle NABUK.

/ Bed given by the combination of two pure forms such as circle and square, it becomes the protagonist in any environment where it is placed. Its special round shape makes it unique and with an original design. Bed made of particles panels covered in NABUK leather.



Night Sets
/ **Gruppi Notte**

Accompagnano i letti i gruppi notte composti da comodini, comò e settimanali. Particolare interesse Night System: contenitori, cassetti, boiserie e tavolini derivati dal programma I-modulART.

The beds are accompanying the sleeping sets consisting of nightstands, drawers and chests of drawers. Particular interest about Night System: storage units, drawers, boiserie and side tables resulting from I-modulART program.

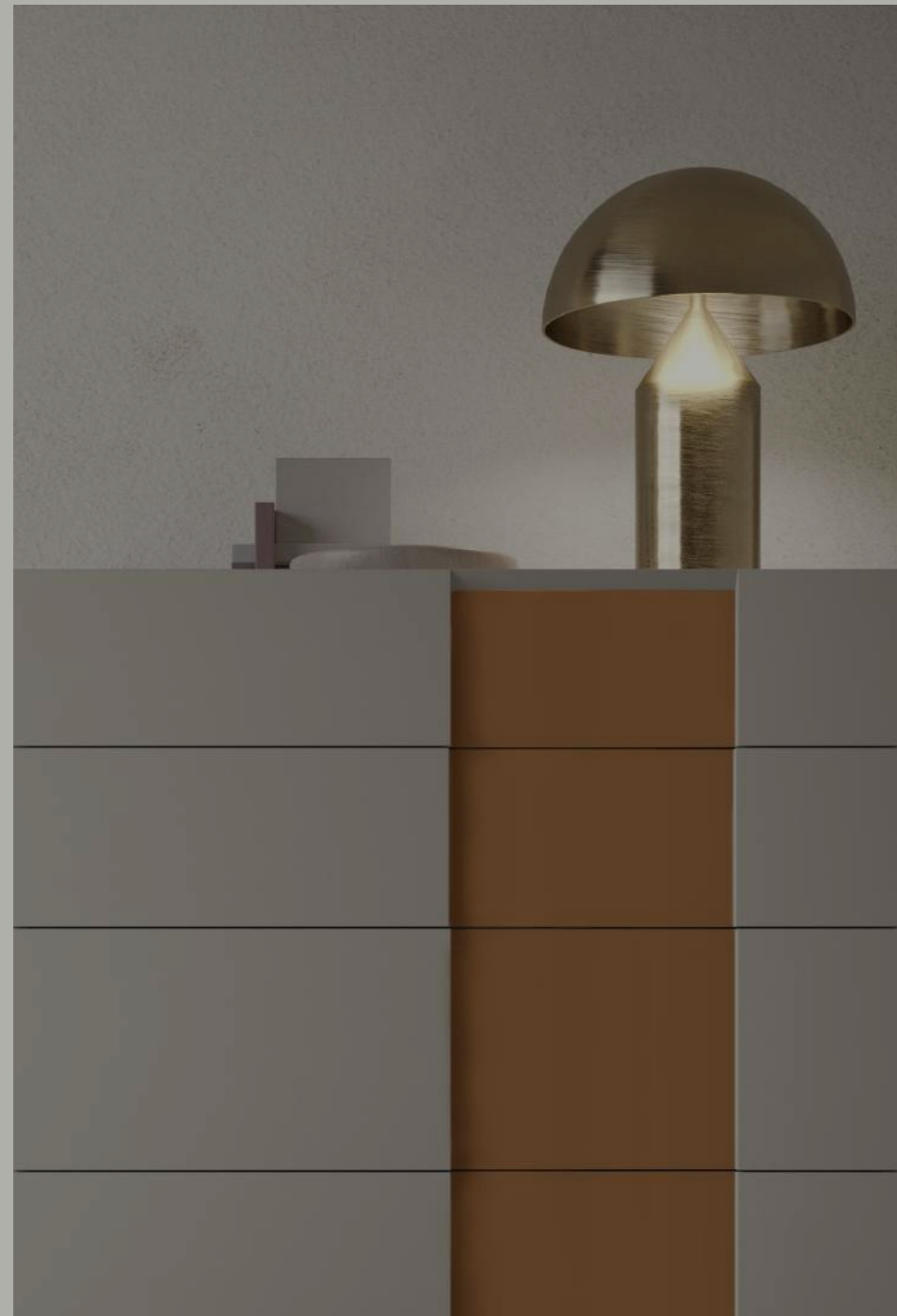

\ SIGMA #44

Night Sets

Particolare comò 6 cassetti in finitura laccato opaco Beige Argilla con maniglia in Metal Standard Bronzo. Gruppo notte Sigma in finitura Grigio Creta opaco con maniglia in Metal Standard Peltro e Arancio Cotto opaco con maniglia in Metal Standard Platino.

/ Special 6-drawers chest in matt Beige Argilla lacquered finish with handle in Bronze Metal Standard. Sigma night set in matt Grigio Creta finish with handle in Pewter Metal Standard and Arancio Cotto matt finish with handle in Platinum Metal Standard.

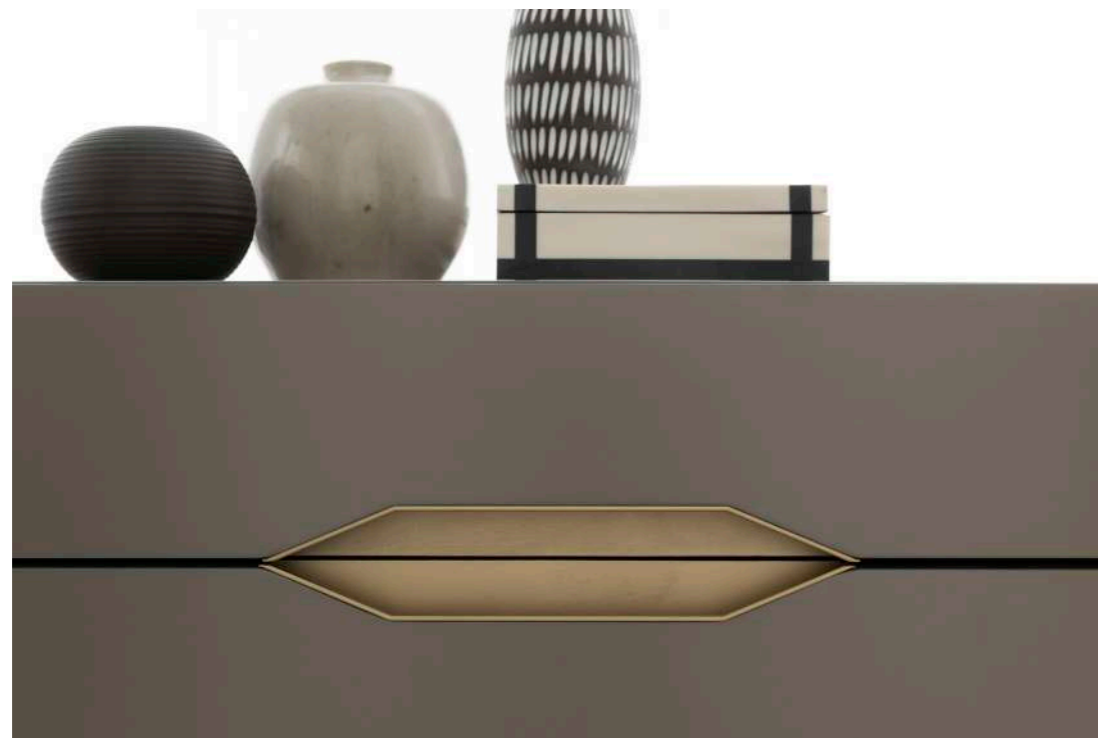

Technical info page 225



\ SIBARI #45

Night Sets

Comò 3 cassetti in
essenza Eucalipto Dark
con top in ecopelle Time.
Comodino in finitura
laccato opaco Tortora.
Gruppo notte Sibari in
finitura Comfort per comò,
laccato opaco Grigio
Londra e Arancio Cotto
per comodini.

/
3-drawers chest in
Eucalyptus Dark wood
veneer with Time
eco-leather top.
Nightstand in matt Tortora
lacquered finishing.
Night set Sibari in
Comfort finish for dresser,
matt Grigio Londra
lacquered and Arancio
Cotto for nightstands.



\DOLLY #46

Night Sets

Comò e comodino in finitura Verde Salvia con gambe in Metal Standard Peltro, a fianco poltroncina Fuller. Gruppo notte Dolly composto da comodino 2 cassetti in Grigio Polvere, comodino 1 cassetto in Verde Oliva con gambe cromate, comò 5 cassetti Arancio Cotto con gambe cromate e comò 6 cassetti in Grigio Polvere.

/ Chest of drawers and nightstand in Verde Salvia finishing with legs in Pewter Metal Standard, at the side Fuller armchair. Dolly night set composed of 2-drawers nightstand in Grigio Polvere, 1-drawer nightstand in Verde Oliva with chrome legs, 5-drawers chest in Arancio Cotto with chrome legs, and 6-drawers chest in Grigio Polvere.



Technical info page 226



Comò 3 cassetti in laccato opaco Grigio Polvere e inserto verticale in essenza Rovere Seppia, a fianco comò 5 cassetti in Grigio Nebbia con inserto in Arancio Cotto.
Gruppo notte composto da comò 3 e 5 cassetti in essenza Eucalipto Dark e inserto verticale in Metal Standard Bronzo, comodini 2 e 3 cassetti in Grigio Antracite con inserto in Gris Beige e laccato Corda con inserto in tinta.

/

3-drawers chest in matt lacquered Grigio Polvere and vertical insert in Seppia Oak veneer, beside 5-drawers chest in Grigio Nebbia with insert in Arancio Cotto.
Night set composed of 3- and 5-drawers chest in Eucalyptus dark wood veneer and vertical insert in Bronze Metal Standard, 2- and 3-drawers nightstands in Grigio Antracite with insert in Gris Beige and Corda lacquered with insert in nuance.



\ WING #48

Night Sets

Comò 6 cassetti con vani a giorno in essenza Noce Canaletto, comò 6 cassetti in laccato opaco Arancio Cotto. Gruppo notte composto da comò 8 e 4 cassetti in laccato Arancio Cotto, comodino 2 cassetti in laccato opaco Grigio Antracite, comodino 2 e 3 cassetti in Rovere Seppia con primo cassetto in Grigio Antracite, comodini comò 6 cassetti in Rovere Seppia.

/
6-drawers chest with open compartments in Canaletto Walnut wood veneer, 6-drawers chest in Arancio Cotto matt lacquered.
Night set composed of 8 and 4-drawers chest in Arancio Cotto lacquered, 2-drawers nightstand in Grigio Antracite matt lacquered, 2 and 3-drawers nightstand in Seppia Oak wood veneer with first drawer in Grigio Antracite, 6-drawers chest and nightstands in Seppia Oak.



Technical info page 227



Comò 5 cassetti in finitura laccato opaco Verde Oliva. Sotto, gruppo notte composto da comò e comodino 3 cassetti in essenza Noce Canaletto, comò 5 cassetti in Bianco Giglio e comodino 3 cassetti in laccato opaco Arancio Cotto. A fianco comò 3 cassetti in essenza Eucalipto Dark.

/
5-drawer chest in Verde Oliva matt lacquered finishing; below, night set composed of chest of drawers and 3-drawers nightstand in Canaletto Walnut wood veneer, 5-drawers chest in Bianco Giglio and nightstand in Arancio Cotto matt lacquered finishing. Next, 3-drawers chest in Eucalyptus Dark wood veneer.



Dettaglio fianco comodino in finitura Arancio Cotto lucido, sotto, gruppo notte composto da comò 5 cassetti in finitura Bianco Neve, comò 3 cassetti in essenza Rovere Seppia, comodino 2 cassetti in Arancio Cotto lucido e comodino 3 cassetti in Grigio Antracite. A fianco comò in essenza Noce Canaletto.

/ Nightstand side detail in Arancio Cotto glossy finishing; below, night set composed of 5-drawers chest in Bianco Neve finishing, 3-drawers chest in Seppia Oak wood veneer, 2-drawers nightstand in Arancio Cotto glossy finishing and 3-drawers nightstand in Grigio Antracite finishing. On the side, chest of drawers in Canaletto Walnut wood veneer.

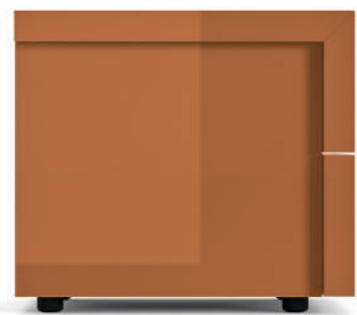

\ JAZZ #51

Night Sets

Comodino e comò
5 cassetti in finitura laccato
opaco Arancio Cotto.
Gruppo notte composto
da comò 5 e 3 cassetti
in finitura laccato opaco
Grigio Tasmania, comodino
2 cassetti in Arancio Cotto
e comodino 3 cassetti
in Marrone Corteccia.

/ Nightstand and 5-drawers
chest in Arancio Cotto
matt lacquered. Night
set consisting of 5 and
3-drawers chest in Grigio
Tasmania matt lacquered
finishing, 2-drawers
nightstand in Arancio Cotto
and 3-drawers nightstand
in Marrone Corteccia.



Technical info page 229



A destra, comò 6 cassetti in finitura laccato opaco Tortora. Sotto, gruppo notte composto da comodino 2 cassetti e comodino 1 cassetto con basamento in finitura laccato opaco Verde Salvia, comò 6 cassetti in Verde Quarzo, comodino 2 cassetti in Arancio Cotto, comò 4 cassetti in essenza Rovere Lince con basamento e retro cassetto in Metal Standard Peltro e comò 5 cassetti in Verde Timo.

/ On the right, 6-drawers chest in Tortora matt lacquered. Below, night set composed of 2-drawers nightstand and 1-drawer nightstand with base in matt Verde Salvia lacquered finishing, 6-drawers chest in Verde Quarzo, 2-drawers nightstand in Arancio Cotto, 4-drawers chest with base in Lince Oak and back-drawer in Pewter Metal Standard, and 5-drawers chest in Verde Timo.



\ GLOBO #53

Night Sets

Comò 3 cassetti in finitura Arancio Cotto con top in marmo Carrara lucido. Particolare vista dall'alto del top in marmo Carrara lucido con cassetto aperto. Gruppo notte formato da comodino in finitura laccato Grigio Tasmania con top in tinta, comodino in finitura laccato lucido Arancio Cotto e comò 3 cassetti con top in marmo Nero Marquinia lucido.

/ 3-drawers chest in Arancio Cotto finishing with Carrara glossy marble top. Detailed view from above of Carrara glossy marble top with open drawer. Night set consisting of nightstand in Grigio Tasmania lacquered finishing with in solid top, nightstand in Arancio Cotto glossy lacquered finishing and 3-drawers chest with Marquinia black glossy marble top.



Small Armchair
/ Poltroncine

In una camera da letto non potevano mancare le poltroncine imbottite rivestite in tessuto o pelle.

| Upholstered armchairs, covered in fabric or leather, could not be missed in a bedroom.



\ FULLER #54

Small armchairs

Poltroncina girevole
rivestita internamente in
tessuto GRANI DI PEPE
ed esternamente in pelle
arancio NABUK.

A destra in versione
con tessuto PARIGINA
accompagnata da pouf
Dama in cuoio intrecciato.

Swivel armchair
upholstered internally
in GRANI DI PEPE fabric
and externally in
NABUK orange leather.
On the right, version
with PARIGINA fabric
accompanied by Dama
pouf in woven saddle
leather.



Technical info page 230



Small armchairs

Clarke: chaise longue dalle forme originali rivestita in pelle New Heavy con gamba in metallo Nero accompagnata da pouf coordinato. Ideale per comode letture serali.

Clarke: originally shaped chaise longue, upholstered in New Heavy leather with Black metal leg accompanied by matching pouf. Ideal for comfortable evening reading.

Milo: poltroncine confortevoli dalle forme morbide, rivestite in vellutino MIMI con gamba in Frassino tinto Nero.

Milo: comfortable armchairs with soft shapes, upholstered in MIMI velvet with leg in Black Stained Ash.



Technical info page 231



Pouf - Benches
/ Pouf - Panche

Prestigiose panche e pouf in cuoio naturale firmate Enzo Mari.

| Prestigious natural leather benches and poufs designer by Enzo Mari.



\ DAMA #57

Pouf / Pouf

Elegante pouf ideato dall'archistar Enzo Mari: un prodotto elegante e raffinato, disponibile in numerose varianti di colore, a destra in cuoio morbido intrecciato color Olmo. Sotto, in color Zucca.

/
Elegant pouf designed by archistar Enzo Mari: an elegant and refined product, available in many color variations, on the right in Elm color soft woven saddle leather. Below in Pumpkin color.

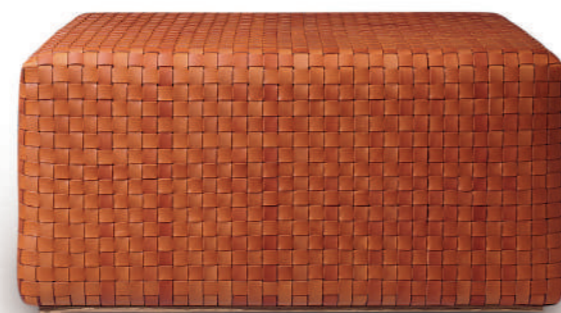

Technical info page 232



\ PILAR #58

Pouf / Pouf

Simpatico pouf rotondo in tessuto VOLT con top in Eucalipto Dark. Qui rappresentato anche in versione con tessuto arancio FOX.

/
Cute round pouf in VOLT fabric with Eucalyptus Dark top. Also shown here in version with orange FOX fabric.



Technical info page 232

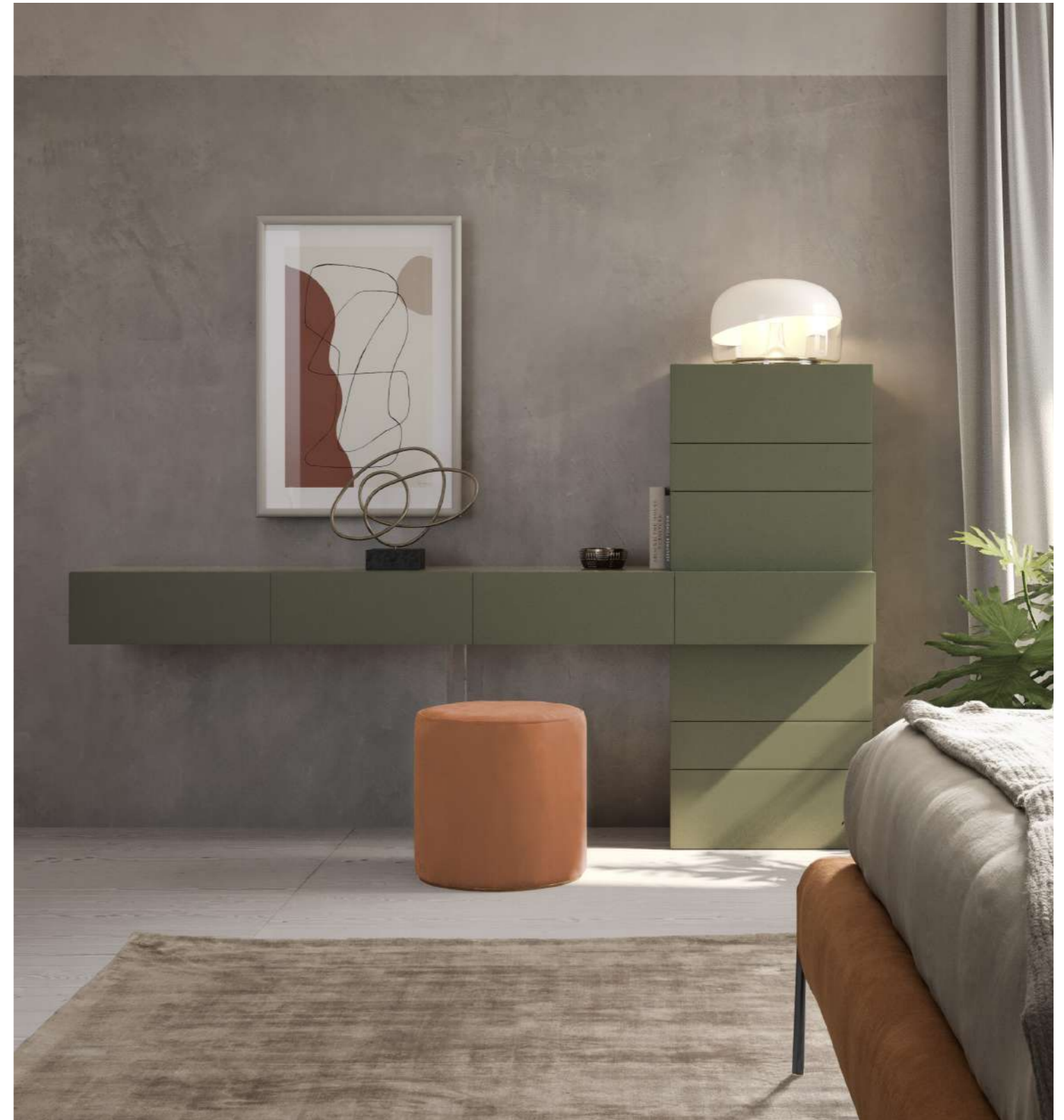

\ QUADRATO #61

Pouf / Pouf

Grazioso pouf rivestito in tessuto o in pelle disponibili in diverse colorazioni. Dotato di piedini di appoggio a terra.

/
Cozy pouf covered in fabric or leather available in different colors. Equipped with ground support feet.



Technical info page 233



\ DORMEUSE #59_SIGMUND #60

Panche / Benches

Eleganti panche ideate da Enzo Mari. Sulla destra Sigmund, struttura in legno di rovere rivestita in cuoio naturale conciato al vegetale ed intrecciato a mano.

Qui rappresentata in cuoio color Castagno.

Sotto: Dormeuse con struttura in legno di rovere, rivestita in cuoio naturale conciato al vegetale.

La panca è dotata di comodo poggiatesta cilindrico in cuoio, disponibile in diverse varianti di colore, qui in cuoio color Zucca.

/
Elegant benches designed by Enzo Mari. On the right you have Sigmund, an oak wood frame covered in natural vegetable-tanned and hand-woven leather. Shown here in Chestnut-colored saddle leather.

Below: Dormeuse with oak wood structure covered in natural vegetable-tanned leather. The bench has a comfortable cylindrical leather headrest, available in different color variations, here in Pumpkin-colored saddle leather.



Technical info pages 233-234



Panca rivestita in pelle,
disponibile in diverse varianti
di colori, qui in pelle SOFT
color terra. Piedini in Metal
Standard Bronzo.

/
Leather upholstered bench,
available in different color,
here in SOFT leather in
earth-color. Bronze Metal
Standard feet.



Writing desks
/ Scrivanie

Scrittoi graziosi e funzionali in legno, in cuoio come Bloom e Squid mentre Caddy è un simpatico tavolino che può anche essere utilizzato in versione Sit&Stand come le moderne tendenze del lavoro d'ufficio.

Pretty and functional desks made of wood, leather like Bloom and Squid while Caddy is a nice coffee table that can also be used in Sit&Stand version, following modern office work trends.



\ CADDY #63

Writing desks

Originale tavolo scrivania contenitore su quattro ruote con piano e antina in Betulla, il volume cilindrico rotante in finitura Rame. Caddy è utile in camera, studio come in cucina. Piano elevabile fino ad un max di H.105 tramite pistone a gas.

Original four-wheeled storage desk table with top and door in Birch, while the rotating cylindrical volume is in Copper finishing. Caddy is useful in the room, study as well as in kitchen. Top can be elevated to a maximum of H.105 by gas piston.

Technical info page 235



A destra, scrittoio in Noce Canaletto e top in vetro satinato nero rappresentato con struttura appoggiata su cassetiera Club 2 in finitura Gris Beige, qui proposta con pouf Pilar in pelle arancio.
Sulla sinistra, struttura e top in Rovere Tabacco, scrittoio appoggiato su cassetiera in finitura laccato Comfort.
/ Right, Canaletto Walnut writing desk and satin black glass top presented with frame resting on Club 2 drawer unit in Gris Beige finishing, here shown with Pilar orange leather pouf.
Left, Tobacco Oak structure and top, desk resting on drawer unit in Comfort lacquered finishing.



Technical info page 235



\ SQUID #65

Writing desks

Sotto, scrittoio multiuso con scudo in morbido cuoio color Zucca, gambe in Metal Standard Peltro, oppure, a destra in Metal Standard Flame con piano in Frassino tinto Nero e scudo in pelle SOFT color Marsala. Qui proposto con sgabello Squid in tessuto.

Below, multipurpose desk with shield in Pumpkin-colored soft saddle leather, legs in Pewter Metal Standard, or, as shown on the right, in Copper Metal Standard with top in Black stained Ash and SOFT leather Marsala colored shield. Proposed here with Squid stool in fabric.

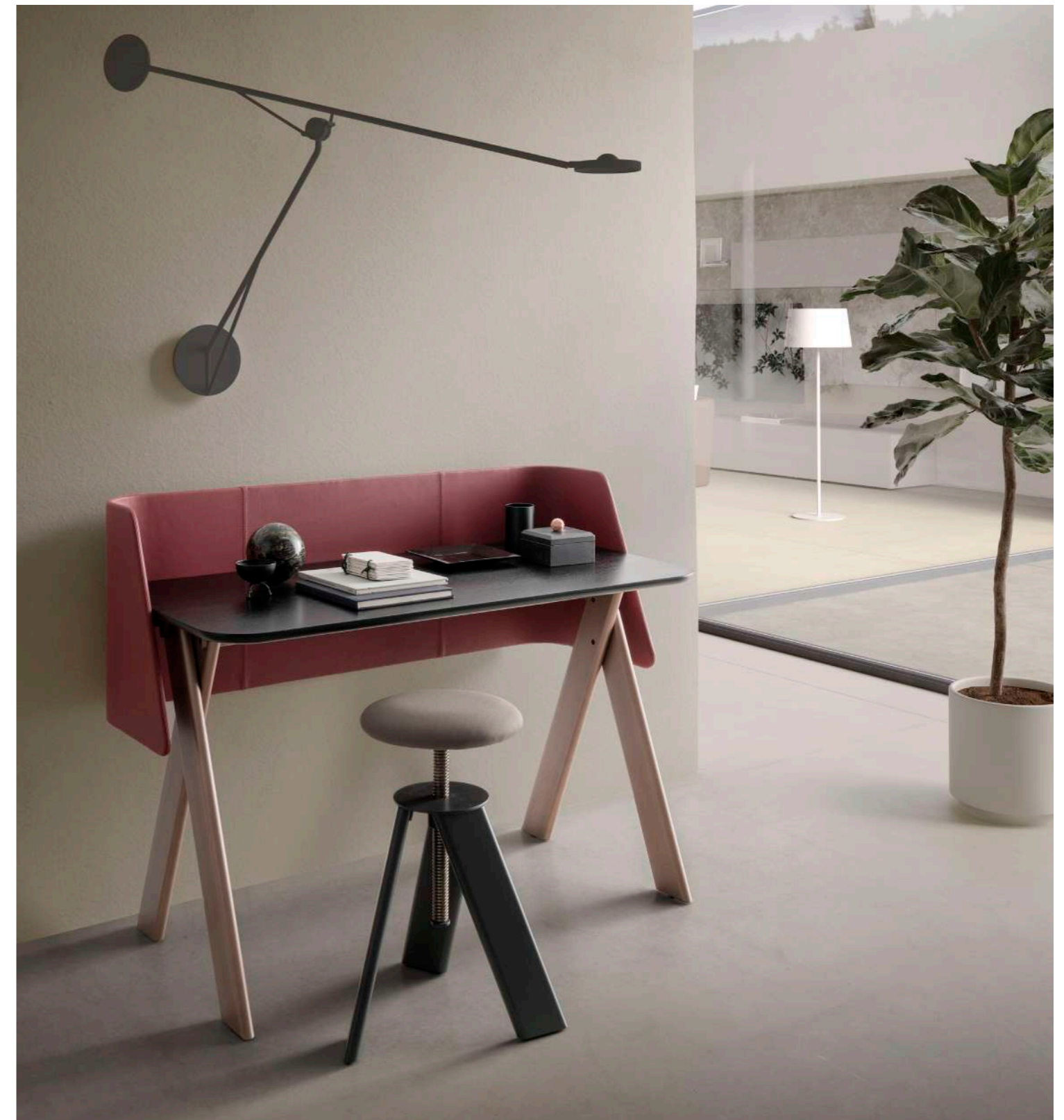
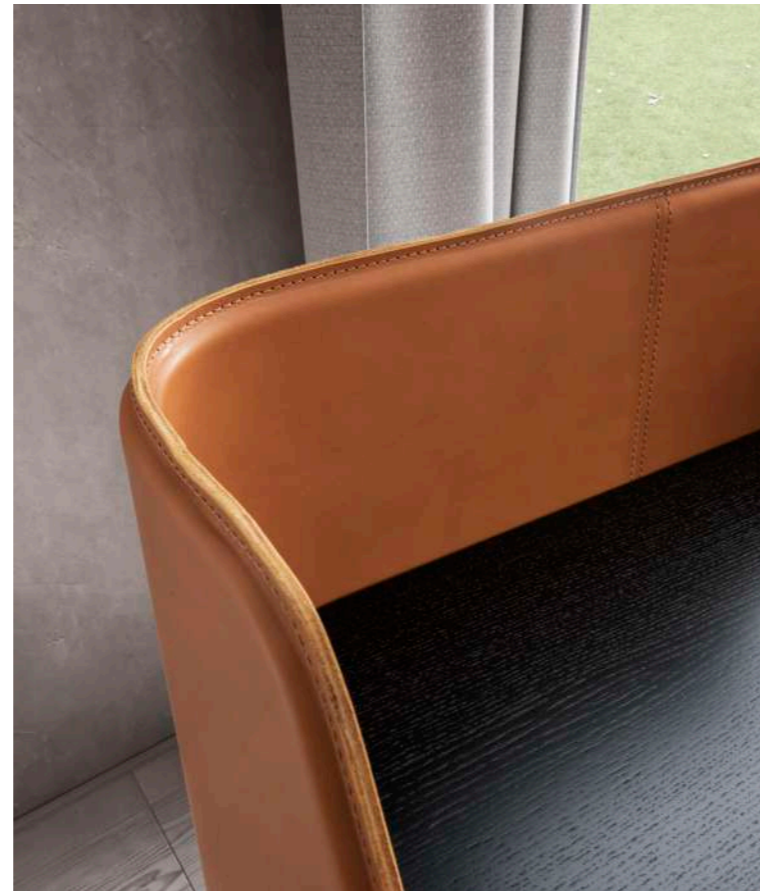

Writing desks

Sorprendente scrivania per home office a forma di plettro. Struttura in Metal Standard Peltro con piano in cuoio morbido Ebano e rivestimento fianchi curvi in essenza Eucalipto Dark. Qui suggerita con sedia Indira.

/
Wonderful pick-shaped home office desk. Structure in Pewter Metal Standard with Ebony soft saddle leather top and curved side covers in Dark Eucalyptus wood veneer. Suggested here with Indira chair.

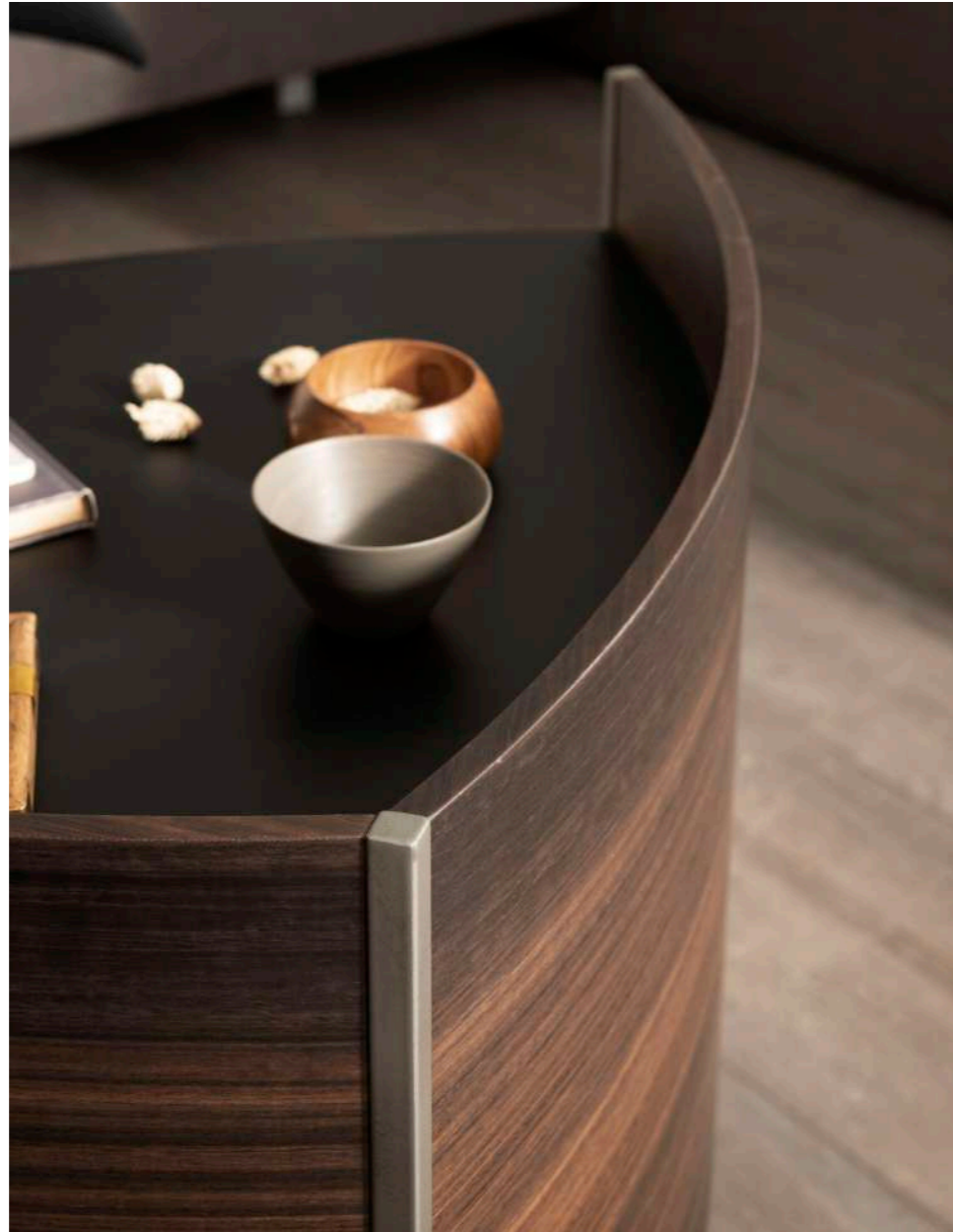

\ MIMESI #67

Mirrors

Forme verticali ed orizzontali contengono uno specchio elegantemente messo in risalto da una cornice svasata in legno verniciata in finitura Metal Standard.

/ Vertical and horizontal shapes hold an elegantly highlighted mirror with a recessed wooden frame, with a Metal Standard varnished finish.

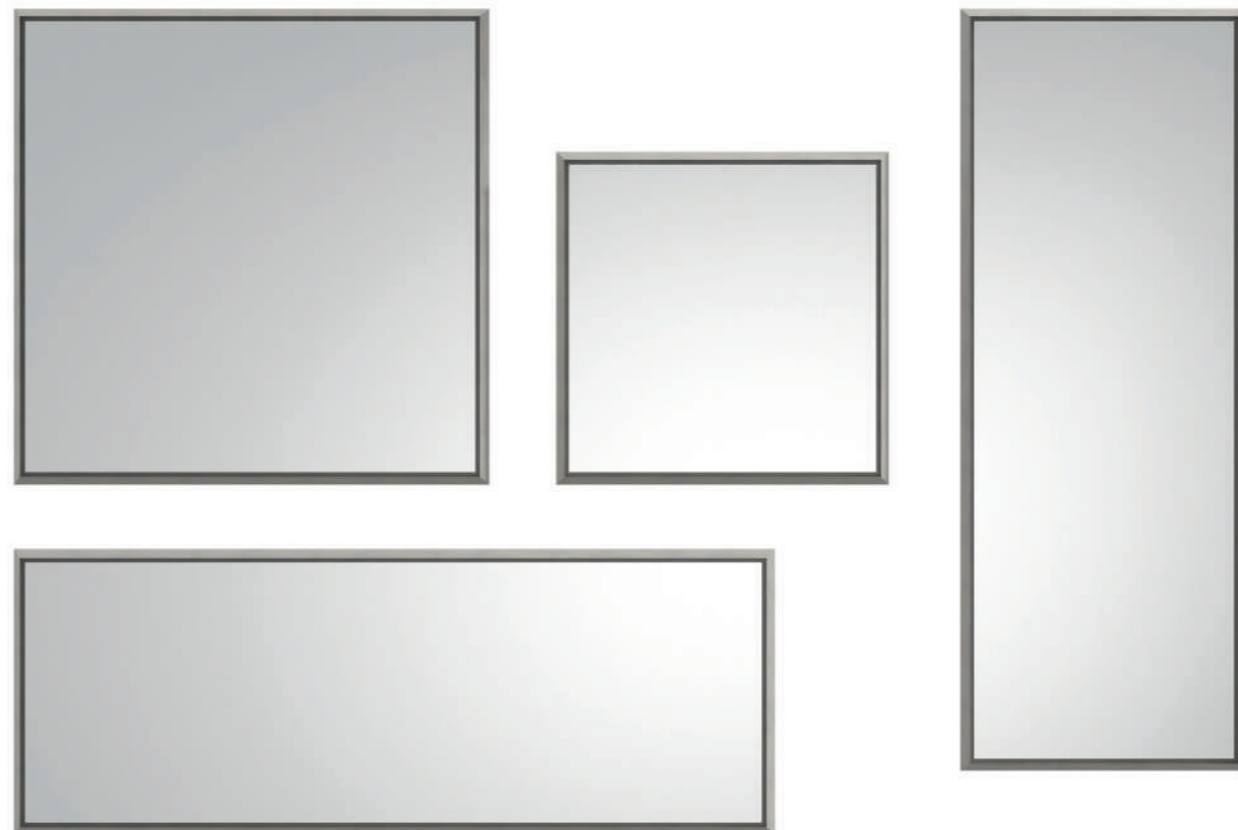

Technical info page 237



TUTTOSPECCHIO #68

Mirrors

Un unico sviluppo verticale ed inclinato, per una specchiera poggiata a parete e a terra su due solidi piedini in metallo cromato. Precisa ed a tutto profilo, con specchio su cinque lati.

/
A special full-length, tilted mirror resting on the wall or on the floor on two solid chrome metal feet. Precise and full profile, with a mirror on five sides.



Caratteristiche tecniche e dimensioni
_Technical features



\ TECNOPOLIS - TECNOPOLIS FREE

TECNOPOLIS CON ANTE BATTENTI, SCORREVOLI E COMPLANARI / TECNOPOLIS WITH HINGED, SLIDING OR COPLANAR DOORS

- fianchi, divisori, coperchi, fondi, ripiani e schiene in nobilitato; porte in laccato, essenza, vetro o ecomalta
- **le schiene possono essere in finitura differente da fianchi e divisori**
- **attrezzatura interna listino Tecnopolis 2022**
- ante battenti: Liscia, NewOne, Meg, Beverly, Sketch, Alibi, Naos, Tau, Glass, Telaio Vetro, Astipalea, Querini
- ante scorrevoli: Liscia, Meg, Glass, L.12, Tris, Tris Tv, Kaleidos, Astipalea, Querini, Sketch
- ante complanari: Tau, Astipalea, Querini, Sketch
- /
- end sides, partitions, tops, bottoms, shelves and backs are in melamine; doors are in Lacquered, Veneer, glass or Ecomalta
- **backs can be in different finish from end sides and partitions**
- **internal equipment from Tecnopolis 2022 price list**
- hinged doors: Liscia, NewOne, Meg, Beverly, Sketch, Alibi, Naos, Tau, Glass, Telaio Vetro, Astipalea, Querini
- sliding doors: Liscia, Meg, Glass, W.12, Tris, Tris Tv, Kaleidos, Astipalea, Querini, Sketch
- coplanar doors: Tau, Astipalea, Querini, Sketch

ALTEZZE / HEIGHTS	MODULO / MODULE
	425-16 ³ / ₄ "
	475-18 ³ / ₄ "
	575-22 ⁵ / ₈ "
2384-93 ⁷ / ₈ "	725-28 ¹ / ₂ "
2544-100 ¹ / ₂ "	875-34 ¹ / ₂ "
2896-114"	975-38 ³ / ₈ "
	1175-46 ¹ / ₄ "
	1325-52 ¹ / ₆ "
	1475-58 ¹ / ₈ "

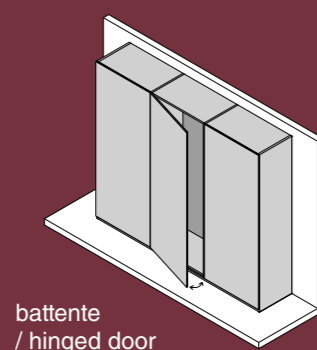

battente
/ hinged door

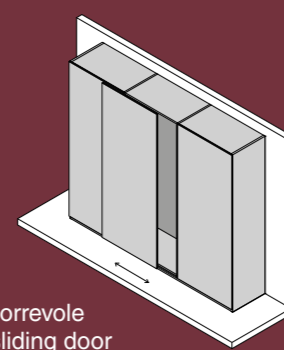

scorrevole
/ sliding door

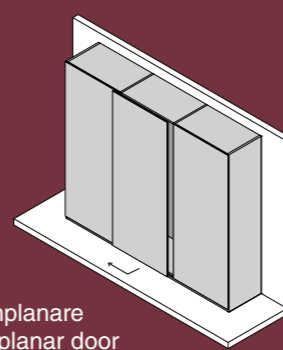

complanare
/ coplanar door

TECNOPOLIS FREE WOOD

- **assenza di ante**
- fianchi, divisori, coperchi, fondi, ripiani e schiene in nobilitato, laccato o essenza
- **le schiene possono essere in finitura differente da fianchi e divisori**
- **attrezzatura interna listino Tecnopolis 2022 o attrezzatura 2023**
- /
- **no doors**
- end sides, partitions, tops, bottoms, shelves and backs are in melamine, lacquered or veneer
- **backs can be in different finish from end sides and partitions**
- **internal equipment from Tecnopolis 2022 price list or 2023 internal equipment**

ALTEZZE / HEIGHTS	MODULO / MODULE
	425-16 ³ / ₄ "
	475-18 ³ / ₄ "
	575-22 ⁵ / ₈ "
2384-93 ⁷ / ₈ "	725-28 ¹ / ₂ "
2544-100 ¹ / ₂ "	875-34 ¹ / ₂ "
2896-114"	975-38 ³ / ₈ "
	1175-46 ¹ / ₄ "

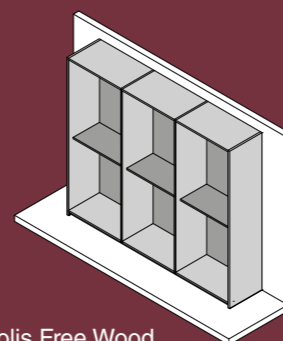

Tecnopolis Free Wood

\ TECNOPOLIS - TENCOPOLIS FREE

TECNOPOLIS FREE WOOD TRA DUE ARMADI / TECNOPOLIS FREE WOOD BETWEEN TWO WARDROBES

- **assenza di ante**
- divisori, coperchi, fondi, ripiani e schiene in nobilitato, laccato o essenza
- **le schiene possono essere in finitura differente da quella dei divisori**
- **attrezzatura interna listino Tecnopolis 2022 o attrezzatura 2023**
- /
- **no doors**
- end sides, partitions, tops, bottoms, shelves and backs are in melamine, lacquered or veneer
- **backs can be in different finish from partitions**
- **internal equipment from Tecnopolis 2022 price list or 2023 internal equipment**

ALTEZZE / HEIGHTS	MODULO / MODULE
	425-16 ³ / ₄ "
	475-18 ³ / ₄ "
	575-22 ⁵ / ₈ "
2384-93 ⁷ / ₈ "	725-28 ¹ / ₂ "
2544-100 ¹ / ₂ "	875-34 ¹ / ₂ "
2896-114"	975-38 ³ / ₈ "
	1175-46 ¹ / ₄ "

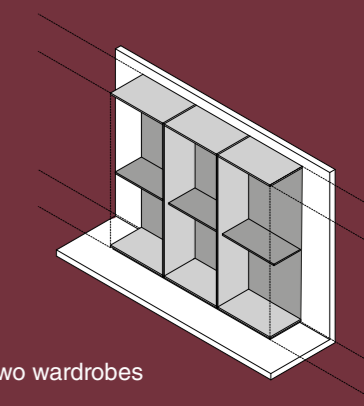

Tecnopolis Free Wood
tra due armadi / between two wardrobes

TECNOPOLIS FREE METAL

- **assenza di ante**
- coperchi, fondi e schiene in nobilitato, laccato o essenza
- fianchi con vetro o passanti, divisori passanti in alluminio Grigio Londra
- ripiani in alluminio Grigio Londra e vetro o in nobilitato, laccato o essenza
- **attrezzatura interna 2023**
- è possibile aggiungere ante vetro cornice 35 con telaio Grigio Londra: le cassettiere saranno solo sospese
- /
- **no doors**
- tops, bottoms and backs are in melamine, lacquered or veneer
- passing frame or glass end sides and passing frame dividers are in Grigio Londra aluminium
- shelves in melamine, lacquered or veneer, or in Grigio Londra aluminium framed glass
- **2023 internal equipment**
- available Vetro Cornice 35 door in Grigio Londra aluminium and glass door: drawer units will only be suspended

ALTEZZE / HEIGHTS	MODULO / MODULE
2384-93 ⁷ / ₈ "	975-38 ³ / ₈ "
2544-100 ¹ / ₂ "	1175-46 ¹ / ₄ "
2896-114"	

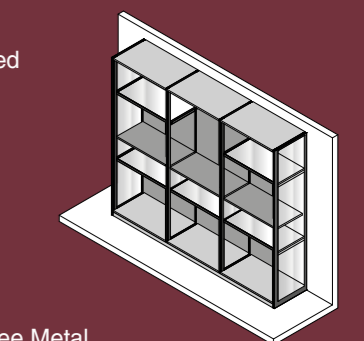

Tecnopolis Free Metal

\ TECNOPOLIS - TENCOPOLIS FREE

TECNOPOLIS FREE METAL TRA DUE ARMADI / TECNOPOLIS FREE METAL BETWEEN TWO WARDROBES

- **assenza di ante**
- coperchi, fondi e schiene in nobilitato, laccato o essenza
- divisori passanti in alluminio Grigio Londra
- ripiani in alluminio Grigio Londra e vetro o in nobilitato, laccato o essenza
- **attrezzatura interna 2023**
- è possibile aggiungere ante vetro cornice 35 con telaio Grigio Londra: le cassettiere saranno solo sospese
- /
- **no doors**
- tops, bottoms and backs are in melamine, lacquered or veneer
- passing frame dividers are in Grigio Londra aluminium
- shelves in melamine, lacquered or veneer, or in Grigio Londra aluminium framed glass
- **2023 internal equipment**
- available Vetro Cornice 35 door in Grigio Londra aluminium and glass door: drawer units will only be suspended

ALTEZZE / HEIGHTS	MODULO / MODULE
2384-93 ⁷ / ₈ "	975-38 ³ / ₈ "
2544-100 ¹ / ₂ "	1175-46 ¹ / ₄ "
2896-114"	

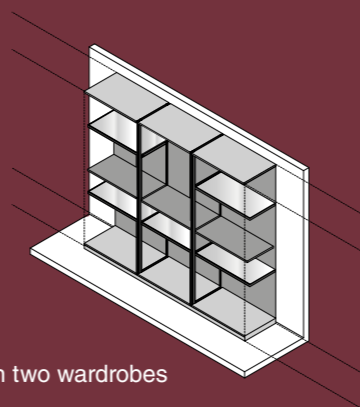

Tecnopolis Free Metal
tra due armadi / between two wardrobes

TECNOPOLIS FREE METAL WOOD

- **assenza di ante**
- coperchi, fondi, schiene e fianchi in nobilitato, laccato o essenza
- divisori passanti in alluminio Grigio Londra
- ripiani in alluminio Grigio Londra e vetro o in nobilitato, laccato o essenza
- **attrezzatura interna 2023**
- è possibile aggiungere ante vetro cornice 35 con telaio Grigio Londra: le cassettiere saranno solo sospese
- /
- **no doors**
- tops, bottoms, backs and end sides are in melamine, lacquered or veneer
- passing frame dividers are in Grigio Londra aluminium
- shelves in melamine, lacquered or veneer, or in Grigio Londra aluminium framed glass
- **2023 internal equipment**
- available Vetro Cornice 35 door in Grigio Londra aluminium and glass door: drawer units will only be suspended

ALTEZZE / HEIGHTS	MODULO / MODULE
2384-93 ⁷ / ₈ "	975-38 ³ / ₈ "
2544-100 ¹ / ₂ "	1175-46 ¹ / ₄ "
2896-114"	

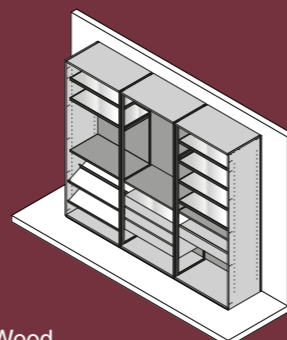

Tecnopolis Free Metal Wood

\ TECNOPOLIS CON ANTE

TECNOPOLIS WITH DOORS

ARMADIO BATTENTE / HINGED DOOR WARDROBE

TIPOLOGIA ANTA / DOOR TYPE	MODULISTICA / MODULE					
	425-16 ³ / ₄ "	475-18 ³ / ₄ "	575-22 ⁵ / ₈ "	875-34 ¹ / ₂ "	975-38 ³ / ₈ "	1175-46 ¹ / ₄ "
Liscia	•	•	•	•	•	•
NewOne	•	•	•	•	•	•
Meg	•	•	•	•	•	•
Beverly	•	•	•	•	•	•
Sketch	•	•	•	•	•	•
Alibi	•	•	-	•	•	-
Naos	•	•	•	•	•	•
Tau	•	•	•	•	•	•
Glass	•	•	•	•	•	•
Telaio vetro	•	•	-	•	•	-
Astipalea	•	•	•	•	•	•
Querini	•	•	•	•	•	•

ARMADIO SCORREVOLE / SLIDING DOOR WARDROBE

TIPOLOGIA ANTA / DOOR TYPE	MODULISTICA / MODULE					
	725-28 ¹ / ₂ "	875-34 ¹ / ₂ "	975-38 ³ / ₈ "	1175-46 ¹ / ₄ "	1325-52 ¹ / ₈ "	1475-58 ¹ / ₈ "
Liscia	•	•	•	-	-	-
Meg	•	•	•	-	-	-
Glass	•	•	•	-	-	-
L.12	•	•	•	•	•	•
Tris	-	-	-	•	•	•
Tris TV	-	-	-	•	•	•
Kaleidos	-	-	-	-	•	•
Astipalea	-	-	•	•	•	•
Querini	-	-	•	•	•	•
Sketch	-	-	•	•	•	•

ARMADIO COMPLANARE / COPLANAR DOOR WARDROBE

TIPOLOGIA ANTA / DOOR TYPE	MODULISTICA / MODULE			
	975-38 ³ / ₈ "	1175-46 ¹ / ₄ "	1325-52 ¹ / ₈ "	1475-58 ¹ / ₈ "
Tau	•	•	•	•
Astipalea	•	•	•	•
Querini	•	•	•	•
Sketch	•	•	•	•

\ ELEMENTI A GIORNO TRA ARMADI

OPEN COMPARTMENT MODULE BETWEEN WARDROBES

COPERCHIO TOP
/ CEILING TOP



H 25 / H 1"
L 606 - 924 - 1242 / W 23 $\frac{3}{8}$ " - 36 $\frac{3}{8}$ " - 48 $\frac{7}{8}$ "
P 604 / D 23 $\frac{3}{4}$ "

RIPIANO LEGNO
/ WOODEN SHELF



H 20 / H $\frac{3}{4}$ "
L 606 - 924 - 1242 / W 23 $\frac{3}{8}$ " - 36 $\frac{3}{8}$ " - 48 $\frac{7}{8}$ "
P 360 / D 14 $\frac{1}{4}$ "

RIPIANO IN VETRO TRASPARENTE
/ TRANSPARENT GLASS SHELF



H 35 / H 1 $\frac{3}{4}$ "
L 606 - 924 - 1242 / W 23 $\frac{3}{8}$ " - 36 $\frac{3}{8}$ " - 48 $\frac{7}{8}$ "
P 360 / D 14 $\frac{1}{4}$ "

DISPLAY A GIORNO
/ OPEN COMPARTMENT DISPLAY



H 450 - 610 / H 24"
L 606 - 924 / W 23 $\frac{3}{8}$ " - 36 $\frac{3}{8}$ "
P 554 / D 21 $\frac{3}{4}$ "

DISPLAY CON ANTA VETRO IN LUCE
/ GLASS FLUSH DOOR DISPLAY

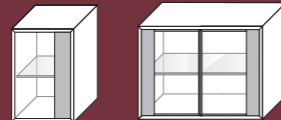

H 450 - 610 / H 24"
L 606 - 924 / W 23 $\frac{3}{8}$ " - 36 $\frac{3}{8}$ "
P 554 / D 21 $\frac{3}{4}$ "

DISPLAY CON CASSETTI IN LUCE
/ FLUSH DRAWERS DISPLAY

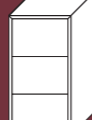

H 610 / H 24"
L 606 - 924 / W 23 $\frac{3}{8}$ " - 36 $\frac{3}{8}$ "
P 554 / D 21 $\frac{3}{4}$ "

DISPLAY CON CESTONE E CASSETTO IN LUCE
/ FLUSH DRAWER AND DEEP DRAWER DISPLAY

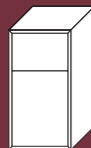

H 610 / H 24"
L 606 - 924 / W 23 $\frac{3}{8}$ " - 36 $\frac{3}{8}$ "
P 554 / D 21 $\frac{3}{4}$ "

DISPLAY SCRITTOIO A RIBALTA
/ FLAP DOOR DESK DISPLAY



H 610 / H 24"
L 924 / W 36 $\frac{3}{8}$ "
P 554 / D 21 $\frac{3}{4}$ "

DISPLAY RIBALTA BAR
/ FLAP DOOR BAR DISPLAY



H 610 / H 24"
L 606 / W 23 $\frac{3}{8}$ "
P 554 / D 21 $\frac{3}{4}$ "

SCHIENE E SPECCHI
/ BACKS AND MIRRORS

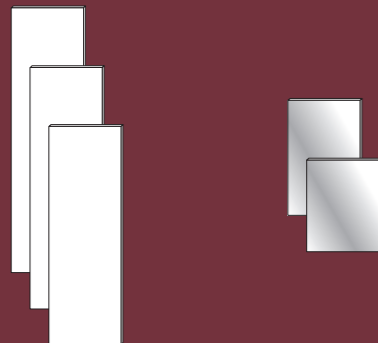

H 2384 - 2544 - 2896
/ H 93 $\frac{3}{8}$ " - 100 $\frac{1}{2}$ " - 114"
L 606 - 924 - 1242
/ W 23 $\frac{3}{8}$ " - 36 $\frac{3}{8}$ " - 48 $\frac{7}{8}$ "
H 800 - 1200
/ H 31 $\frac{1}{2}$ " - 47 $\frac{1}{4}$ "
L 606 - 924 - 1242
/ W 23 $\frac{3}{8}$ " - 36 $\frac{3}{8}$ " - 48 $\frac{7}{8}$ "

SCRITTOIO FLY
/ FLY WRITING DESK

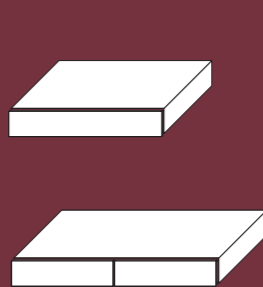

H 96 / H 3 $\frac{3}{4}$ "
L 924 - 1242 / W 36 $\frac{3}{8}$ " - 48 $\frac{7}{8}$ "
P 554 / D 21 $\frac{3}{4}$ "

CASSETTIERA
/ CHEST OF DRAWERS

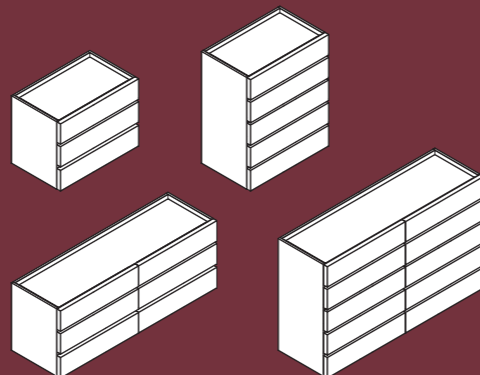

H 596 - 1073 / H 23 $\frac{1}{2}$ " - 42 $\frac{1}{4}$ "
L 606 - 924 - 1242 / W 23 $\frac{3}{8}$ " - 36 $\frac{3}{8}$ " - 48 $\frac{7}{8}$ "
P 533 / D 21"

\ ATTREZZATURA 2023

2023 EQUIPMENT

CASSETTIERA
/ CHEST OF DRAWERS

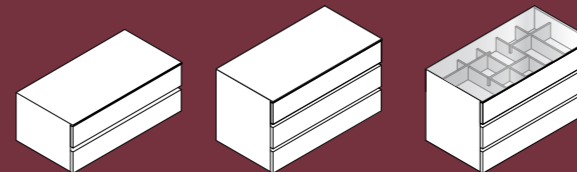

H 400 - 600 / H 15 $\frac{3}{4}$ " - 23 $\frac{3}{8}$ "
L 975 - 1175 / W 38 $\frac{3}{8}$ " - 46 $\frac{1}{4}$ "
P 512 / D 20 $\frac{1}{2}$ "

SCARPIERA
/ SHOE RACK



H 100 / H 3 $\frac{3}{8}$ "
L 975 - 1175 / W 38 $\frac{3}{8}$ " - 46 $\frac{1}{4}$ "
P 512 / D 20 $\frac{1}{2}$ "

RIPIANO IN LEGNO
/ WOODEN SHELF

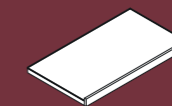

H 30 / H 11 $\frac{1}{8}$ "
L 975 - 1175 / W 38 $\frac{3}{8}$ " - 46 $\frac{1}{4}$ "
P 512 / D 20 $\frac{1}{2}$ "

RIPIANO IN VETRO TRASPARENTE
/ TRANSPARENT GLASS SHELF

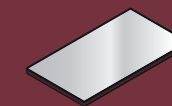

H 35 / H 1 $\frac{3}{8}$ "
L 975 - 1175 / W 38 $\frac{3}{8}$ " - 46 $\frac{1}{4}$ "
P 512 / D 20 $\frac{1}{2}$ "

PORTAPANTALONI
/ TROUSERS RACK

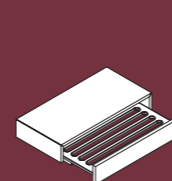

H 200 / H 7 $\frac{7}{8}$ "
L 975 - 1175 / W 38 $\frac{3}{8}$ " - 46 $\frac{1}{4}$ "
P 512 / D 20 $\frac{1}{2}$ "

ASTE APPENDIABITI
/ CLOTHES RAIL



L 975 - 1175 / W 38 $\frac{3}{8}$ " - 46 $\frac{1}{4}$ "

COPPIA ASTE APPENDIABITI PER ANGOLO
/ PAIR OF CLOTHES RAILS FOR CORNER

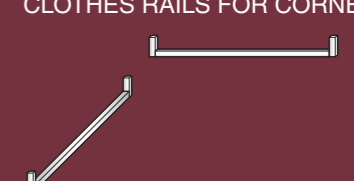

L 759 / W 29 $\frac{3}{8}$ "

FORCELLA APPENDIABITI
/ FORK CLOTHES HANGER



SERVETTO
/ CLOTHES LIFT

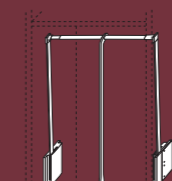

ASTINA APPENDIGRUCCIA
/ HANGER RAIL

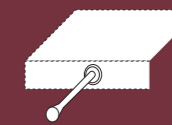

\ WING #31

Letto_Bed / design: Pierangelo Sciuoto

Pag. 114-117



Letto con testiera imbottita sp. 80 mm sospesa a muro rivestita in tessuto, ecopelle o pelle e con pannello boiserie opzionale. La rete a doghe delimitata da una cornice perimetrale imbottita è sostenuta da un piede in metacrilato h 219 mm con illuminazione a led di cortesia opzionale. Il letto è disponibile anche con ring a terra e in versione contenitore. Testiera disponibile in molteplici configurazioni simmetriche o asimmetriche.

Bed with 80 mm thk hanging headboard upholstered in fabric, eco-leather or leather with optional boiserie panel. The slatted base bordered by an upholstered perimeter frame is supported by a methacrylate H 219 mm foot with optional courtesy LED lighting. The bed is also available with a floor ring and in storage version. Headboard is available in multiple symmetrical or asymmetrical configurations.

DIMENSIONI / SIZE

con cornice perimetrale / with perimetral frame

L 1690__W 66 ½”	L 1690__W 66 ½”
P 2175__D 85 ¾”	P 2225__D 87 ¾”
H 917__H 36 ⅛”	H 917__H 36 ⅛”

L 1890__W 74 ¾”	L 2030__W 79 ¾”
P 2175__D 85 ¾”	P 2225__D 87 ¾”
H 917__H 36 ⅛”	H 917__H 36 ⅛”

con ring / with ring

L 1710__W 67 ¾”	L 1910__W 75 ¼”
P 2205__D 86 ¾”	P 2205__D 86 ¾”
H 917__H 36 ⅛”	H 917__H 36 ⅛”

L 1660__W 65 ¾”	L 2050__W 80 ¾”
P 2255__D 88 ¾”	P 2255__D 88 ¾”
H 917__H 36 ⅛”	H 917__H 36 ⅛”

\ FEZ #32/33

Letto_Bed / design: gherardiarchitetti

Pag. 118-121



Letto con morbida testata rivestita in tessuto, pelle o tecnopelle sfoderabile. Caratterizzato da una testiera formata da due cuscini in falda accoppiata e maglina rivestita in tessuto, pelle o tecnopelle. Nella versione in pelle il rivestimento del giroletto viene realizzato con una cucitura centrale su ogni lato. Piede in finitura nero opaco o metal standard. La testiera poggia su piedi distanziatori H 10 mm.

Bed with soft headboard upholstered in fabric, leather or eco-leather. Characterized by a headboard consisting of two cushions made of laminated flap and jersey covered in fabric, leather or eco-leather. In the leather version, the upholstery of the bed frame is made with a central seam on each side. Feet in matt black or metal standard finish. The headboard rests on H 10 mm spacer feet.

DIMENSIONI / SIZE

L 1930__W 76”	L 1930__W 76”
P 2343__D 92 ¼”	P 2395__D 94 ¼”
H 970__H 38 ¼”	H 970__H 38 ¼”

L 2130__W 83 ¾”	L 2270__W 89 ¾”
P 2343__D 92 ¼”	P 2395__D 94 ¼”
H 970__H 38 ¼”	H 970__H 38 ¼”

\ DOLLY LARA #34

Letto_Bed / design: Stefano Gallizioli

Pag. 122-125



La struttura portante della testiera è in legno curvato di multistrato di pino, rivestito da gomma e poi tessuto o pelle. La struttura portante del giroletto imbottita, sostiene la rete a doghe di faggio. Due tipologie di sommier disponibili: giroletto a terra, con possibilità di avere un ampio contenitore sotto rete, oppure giroletto sospeso con piedini in metallo cromato o verniciati metal standard.

The headboard supporting structure is made of curved poplar plywood, covered with feather, upholstered in fabric or leather. The upholstered supporting structure of the bed frame, carries the beech slatted bed base. Two types of sommier are available: ground bed frame, with the possibility of having a large storage unit under the bed base, or suspended bed frame with chromed or metal standard feet.

DIMENSIONI / SIZE

L 2000__W 78 ¾”
P 2250__D 88 ¾”
H 1120__H 44 ⅛”

L 2200__W 86 ¾”	L 2330__W 91 ¾”
P 2250__D 88 ¾”	P 2280__D 89 ¾”
H 1120__H 44 ⅛”	H 1120__H 44 ⅛”

\ DOLLY ROSE #35

Letto_Bed / design: Stefano Gallizioli

Pag. 126-129



Letto di design caratterizzato da una lunga testiera lineare imbottita e rivestita in tessuto, pelle o ecopelle che, a seconda della tipologia, sporge rispetto al sommier. La struttura portante del giroletto è in legno di faggio e pino, rivestita anch'essa in tessuto o pelle.

Design bed characterized by a long linear headboard upholstered and covered in fabric, leather or ecoleather which, depending on the type, protrudes from the sommier. The supporting structure of the bed frame is made of beech and poplar wood.

DIMENSIONI / SIZE

L 2200__W 86 ¾”
P 2250__D 88 ¾”
H 1070__H 42 ⅛”

L 2400__W 94 ½”	L 2400__W 94 ½”
P 2250__D 88 ¾”	P 2280__D 89 ¾”
H 1070__H 42 ⅛”	H 1070__H 42 ⅛”

\ NIOBE #36

Letto_Bed / design: gherardiarchitetti

Pag. 130-133



Letto con struttura autoportante realizzata con pannelli rivestiti in tessuto, pelle o ecopelle. La testiera è sfoderabile solo nella versione in tessuto; il giroletto invece, è sempre sfoderabile. Letto fornibile in molteplici configurazioni con testiera simmetrica o asimmetrica rispetto al giroletto. Disponibile anche nella versione con rete e meccanismo contenitore a uno o due movimenti.

/
Bed with self-supporting frame covered in fabric, leather or eco-leather. The headboard is removable only in the fabric version; the bed frame cover is always removable. Bed available in multiple configurations with symmetrical or asymmetrical headboard. Also available with bed base and storage mechanism, with one or two movements.

DIMENSIONI / SIZE

L 1928-2736-3020	L 1928-2736-3020
__W 75 7/8"-107 3/4"-118 7/8"	__W 75 7/8"-107 3/4"-118 7/8"
P 2160__D 85"	P 2210__D 87"
H 906-970-1162	H 906-970-1162
__H 35 5/8"-38 1/8"-45 3/4"	__H 35 5/8"-38 1/8"-45 3/4"

L 2128-2936-3220	L 2268-3076-3350
__W 75 7/8"-107 3/4"-118 7/8"	__W 75 7/8"-107 3/4"-118 7/8"
P 2160__D 85"	P 2210__D 87"
H 906-970-1162	H 906-970-1162
__H 35 5/8"-38 1/8"-45 3/4"	__H 35 5/8"-38 1/8"-45 3/4"

\ CALI #37

Letto_Bed / design: gherardiarchitetti

Pag. 134-137



Letto con struttura rivestita in tessuto, pelle o ecopelle. La struttura con rivestimento sfoderabile, è caratterizzata da due cuscini in appoggio realizzati in piuma e rivestita in tessuto, pelle o ecopelle sempre sfoderabili. I cuscini sono disponibili anche con un rivestimento in contrasto rispetto a quello della struttura.

/
Bed with structure covered in fabric, leather or eco-leather. The structure with removable cover is characterized by two supporting cushions with removable cover too, made of feather and covered in fabric, leather or eco-leather. The cushions are also available in a finish contrasting with the structure.

DIMENSIONI / SIZE

L 1715__W 67 1/2"	L 1715__W 67 1/2"
P 2276__D 89 5/8"	P 2328__D 91 5/8"
H 886__H 34 7/8"	H 886__H 34 7/8"

L 1915__W 75 3/8"	L 2055__W 80 7/8"
P 2276__D 89 5/8"	P 2328__D 91 5/8"
H 886__H 34 7/8"	H 886__H 34 7/8"

\ PLANA #38

Letto_Bed / design: Claudio Lovadina

Pag. 138-141



Struttura realizzata in pannelli in MDF, disponibile in laccato opaco o metal standard. Gamba in metacrilato disponibile anche con luce led. Completo di rete integrata con doghe di faggio. Tra queste, 6 sono dotate di regolatori di rigidità e 4 sono a resistenza differenziata per l'appoggio della spalla.

/
Structure made of MDF board available in matt lacquered or metal standard. Methacrylate leg is also available with led light. Complete with integrated bed base with beech slats. Of these, 6 are equipped with rigidity adjusters and 4 are with differentiated resistance for shoulder support.

DIMENSIONI / SIZE

L 1160__W 45 5/8"	L 1960__W 77 1/8"
P 2250__D 88 5/8"	P 2250__D 88 5/8"
H 938__H 36 7/8"	H 938__H 36 7/8"

L 1360__W 53 1/2"	L 1760__W 69 1/4"
P 2250__D 88 5/8"	P 2300__D 90 1/2"
H 938__H 36 7/8"	H 938__H 36 7/8"

L 1760__W 69 1/4"	L 2100__W 82 5/8"
P 2250__D 88 5/8"	P 2300__D 90 1/2"
H 938__H 36 7/8"	H 938__H 36 7/8"

\ RELEVÉ #39

Letto_Bed / design: gherardiarchitetti

Pag. 142-145



Giroletto realizzato in legno impiallacciato in noce canaletto, rovere tabacco o rovere dark. Testiera imbottita rivestita in ecopelle o pelle, disponibile anche in versione con testiera in essenza noce canaletto, rovere tabacco o rovere dark.

La superficie interna delle gambe è in laccato opaco.

/
Structure made of wood veneer in canaletto walnut, tobacco oak or dark oak. Upholstered headboard in eco-leather or leather, also available in canaletto walnut, tobacco oak or dark oak veneer versions. The internal legs surface is matt lacquered.

DIMENSIONI / SIZE

L 1768__W 69 5/8"	L 1718__W 67 5/8"
P 2168__D 85 3/8"	P 2219__D 87 3/8"
H 885__H 34 7/8"	H 885__H 34 7/8"

L 1968__W 77 1/2"	L 2108__W 83"
P 2168__D 85 3/8"	P 2219__D 87 3/8"
H 885__H 34 7/8"	H 885__H 34 7/8"

\ MEETING UP #40

Letto_Bed / design: Presotto studio

Pag. 146-149



Meeting Up è un letto imbottito, rivestito in tessuto o ecopelle sfoderabile. La testiera e il giroletto sono caratterizzati da una combinazione di due rivestimenti che possono appartenere a categorie e colori diversi tra loro.

/ Meeting Up is an upholstered bed, covered in removable fabric or eco-leather. The headboard and bed frame feature a combination of two different upholsters.

DIMENSIONI / SIZE

L 1774__W 69 7/8"
P 2240-2290__D 88 1/8"-90 1/8"
H 1100__H 43 1/4"

L 1974__W 77 3/4" L 2114__W 83 1/4"
P 2240__D 88 1/8" P 2290__D 90 1/8"
H 1100__H 43 1/4" H 1100__H 43 1/4"

\ AQUA #41 #42

Letto_Bed / design: Pierangelo Sciuto

Pag. 150-153



Struttura realizzata in multistrato curvato disponibile in laccato opaco o impiallacciato in Noce Canaletto, Rovere Seppia o Rovere Dark. Completo di rete integrata autoportante con doghe di faggio. Tra queste, 6 sono dotate di regolatori di rigidità e 4 sono a resistenza differenziata per l'appoggio della spalla. Basamento in metacrilato disponibile anche con luce led.

/ Structure made of curved plywood available in matt lacquered or in Canaletto Walnut, Seppia Oak or Dark Oak veneer. Complete with integrated self-supporting bed base with beech slats. Of these, 6 are equipped with stiffness adjusters and 4 are with differentiated resistance for shoulder support. Methacrylate base also available with led light.

DIMENSIONI / SIZE

L 1870__W 73 3/8" L 1820__W 71 5/8"
P 2295__D 90 3/8" P 2344__D 92 1/4"
H 830__H 32 3/8" H 830__H 32 3/8"

L 2070__W 81 1/2" L 2210__W 87"
P 2295__D 90 3/8" P 2344__D 92 1/4"
H 830__H 32 3/8" H 830__H 32 3/8"

\ ZERO #43

Letto_Bed / design: Pierangelo Sciuto

Pag. 154-157



Letto tondo con testiera rivestita in ecopelle o pelle, non sfoderabile. I ring sono realizzati in pannelli di particelle e massello di abete, rivestiti con ecopelle o pelle, non sfoderabile. Il letto è disponibile in 2 dimensioni: Medium e Large.

/ Round bed with headboard covered with eco-leather or leather, not removable. Rings are made of particle board and solid fir wood, covered with eco-leather or leather, with non-removable covers. The bed is available in 2 sizes: Medium and Large.

DIMENSIONI / SIZE

L 2364__W 63 1/8" L 2700__W 106 1/4"
P 2507-2557__D 98 3/4"-100 5/8"
H 937__H 36 7/8" P 2570-2620__D 101 1/8"-103 1/8"
H 937__H 36 7/8" H 937__H 36 7/8"

L 2564__W 101" L 2900__W 114 1/8"
P 2507__D 98 3/4" P 2570__D 101 1/8"
H 937__H 36 7/8" H 937__H 36 7/8"

\ SIGMA #44

Gruppo Notte_Night Set / design: gherardiarchitetti

Pag. 160-161



Gruppo notte con struttura realizzata in particelle di legno, disponibile in laccato opaco o essenza. Apertura con maniglia in laccato opaco o metal standard, incassata nello spessore del frontale.

/ Night set with wood particle board structure, available in matt lacquered or wood veneer. Opening with matt lacquered or standard metal handle, recessed in the thickness of the front.

DIMENSIONI / SIZE

Comodino 2 cassetti
/ 2 drawers night stand
L 353-453-553-753__W 13 7/8"-17 7/8"-21 3/4"-29 5/8"
P 436__D 17 1/8"
H 372__H 14 5/8"
Comò 3 cassetti
/ 3 drawers dresser
L 1439__W 56 5/8"
P 532__D 21"
H 723__H 28 1/2"

Comodino 3 cassetti
/ 3 drawers night stand
L 353-453-553-753__W 13 7/8"-17 7/8"-21 3/4"-29 5/8"
P 436__D 17 1/8"
H 500__H 19 5/8"
Comò 5 cassetti
/ 5 drawers dresser
L 853__W 33 5/8"
P 532__D 21"
H 1074__H 42 1/4"

\ SIBARI #45

Gruppo Notte_Night Set / design: gherardiarchitetti

Pag. 162-163



Gruppo notte con struttura realizzata in particelle di legno disponibile in laccato opaco o in essenza. Si distingue per i frontali dal forte spessore con prese maniglia ergonomiche e la personalizzazione del piano incassato disponibile in laccato opaco, essenza o ecopelle.

Night set with structure made of particle board, available in matt lacquered or wood veneer. Featuring thick fronts with ergonomic handles recessed into their edges and customised, recessed top available in matt lacquered, veneer or eco-leather.

DIMENSIONI / SIZE

Comodino 2 cassetti
/ 2 drawers night stand

L 353-453-553-753__W 13 ¾"-17 ¾"-21 ¾"-29 ¾"
P 436__D 17 ½"
H 372__H 14 ¾"

Comodino 3 cassetti
/ 3 drawers night stand

L 353-453-553-753__W 13 ¾"-17 ¾"-21 ¾"-29 ¾"
P 436__D 17 ½"
H 596__H 23 ½"

Comò 3 cassetti
/ 3 drawers dresser

L 1439__W 56 ¾"
P 532__D 21"
H 723__H 28 ½"

Comò 5 cassetti
/ Dresser 5 drawers

L 853__W 33 ¾"
P 532__D 21"
H 1074__H 42 ¼"

\ DOLLY #46

Gruppo Notte_Night Set / design: Stefano Gallizioli

Pag. 164-165



Gruppo notte con struttura realizzata in particelle di legno in laccato opaco o lucido con possibilità di avere il top in appoggio in vetro lucido retrolaccato o in ceramica. Cassetto superiore con apertura prensile, gli inferiori con apertura push-pull. Base cromata, disponibile anche nella versione in nichel nero, in epossidico nero o in metal standard.

Night set with structure made of wood particles in matt or glossy lacquered; top is available in back-lacquered glossy glass or ceramic. Upper drawer with handle grip, lower ones with push-pull opening. Chromed base also available in black nickel, black epoxy or metal standard finishes.

DIMENSIONI / SIZE

Comodino 2 cassetti
/ 2 drawers night stand

L 700__W 27 ½"
P 450__D 17 ¾"
H 340__H 13 ¾"

Comodino 3 cassetti
/ 3 drawers night stand

L 500__W 19 ¾"
P 450__D 17 ¾"
H 500__H 219 ¾"

Comò 4 cassetti
/ 4 drawers dresser

L 1200__W 47 ¼"
P 550__D 21 ¾"
H 710__H 28"

Comò 5 cassetti
/ 5 drawers dresser

L 900__W 35 ¾"
P 550__D 221 ¾"
H 880__H 34 ¾"

CON BASAMENTO / WITH BASE

Comodino 1 cassetto-Tavolino
/ 1 drawers night stand-Small table

L 500__W 19 ¾"
P 450__D 17 ¾"
H 500__H 19 ¾"

Comò 3 cassetti
/ 3 drawers dresser

L 1700__W 66 ¾"
P 550__D 21 ¾"
H 710__H 28"

Comò 4 cassetti
/ 4 drawers dresser

L 1200__W 47 ¼"
P 550__D 21 ¾"
H 880__H 34 ¾"

Comò 5 cassetti
/ 5 drawers dresser

L 900__W 35 ¾"
P 550__D 21 ¾"
H 1050__H 41 ¾"

\ INSIDE #47

Gruppo Notte_Night Set / design: Pierangelo Sciuto

Pag. 166-167



Gruppo notte con struttura realizzata in particelle di legno in laccato opaco. Frontali realizzati in MDF caratterizzati da un inserto verticale personalizzabile in finitura laccato opaco, metal standard o essenza. Apertura con prensilità ad incasso sul frontale.

Night set with structure made of wood particle board in matt lacquered. Fronts are made of MDF, featuring a customizable vertical insert in matt lacquered, metal standard or wood veneer. Opening with recessed prehension on the front.

DIMENSIONI / SIZE

Comodino 2 cassetti
/ 2 drawers night stand

L 360-460-560-760__W 14 ¼"-18 ½"-22"-29 ¾"
P 436__D 17 1/8" H 14 ¾"
H 376__H 14 ¾"

Comodino 3 cassetti
/ 3 drawers night stand

L 360-460-560-760__W 14 ¼"-18 ½"-22"-29 ¾"
P 436__D 17 ½"
H 507__H 20"

Comò
/ Dresser

L 1446__W 56 ¾"
P 532__D 21"
H 728__H 28 ¾"

Settimanale
/ Narrow drawer chest

L 860__W 56 ¾"
P 532__D 21"
H 1079__H 42 ½"

\ WING #48

Gruppo Notte_Night Set / design: Pierangelo Sciuto

Pag. 168-169



Gruppo notte con struttura realizzata in particelle di legno, disponibile in laccato opaco o in essenza. Disponibili con vani a giorno o con frontali, realizzati in MDF. Apertura con prensilità laterale.

Night set with structure made of particle board, available in matt lacquered or wood veneer. Available with open compartments or with fronts in MDF. Opening with side grooving handle.

DIMENSIONI / SIZE

Comodino 1 cassetto
/ 1 drawers night stand

L 553__W 121 ¾"
P 438__D 17 ¼"
H 129__H 5 ½"

Comodino 2 cassetti orizzontali
/ 2 drawers night stand

L 1105__W 40"
P 438__D 17 ¼"
H 129__H 5 1/8"

Comodino 2 cassetti
/ 2 drawers night stand

L 353-453-553-753__W 13 ¾"-17 ¾"-21 ¾"-29 ¾"
P 417__D 16 ¾"
H 372__H 5 ½"

Comodino 3 cassetti
/ 3 drawers night stand

L 353-453-553-753__W 13 ¾"-17 ¾"-21 ¾"-29 ¾"
P 417__D 19 ¾"
H 500__H 19 ¾"

Comò 2 cassetti
/ 2 drawers dresser

L 853__W 33 ¾"
P 512__D 20 ½"
H 372__H 14 ¾"

Comò 4 cassetti
/ 4 drawers dresser

L 853__W 33 ¾"
P 512__D 20 ½"
H 723__H 28 ½"

Comò 8 cassetti
/ 8 drawers dresser

L 1105-1405__W 43 ½"-55 ¼"
P 512__D 20 ½"
H 723__H 28 ½"

Settimanale
/ Narrow drawer chest

L 853__W 33 ¾"
P 512__D 20 ½"
H 1074__H 42 ¼"

Settimanale con vani a giorno
/ Narrow drawer chest with cubby holes

L 987__W 38 ¾"
P 512__D 20 ½"
H 1074__H 42 ¼"

\ CLUB #49

Gruppo Notte_Night Set / design: Pierangelo Sciuoto

Pag. 170-171



Gruppo notte con struttura e frontali sp. 40 mm realizzati in particelle di legno, disponibile in laccato opaco o in essenza.

Apertura con maniglia nascosta, incassata nello spessore del frontale.

/

Night set with 40 mm thick structure and fronts in wood particle board, available in matt lacquer or wood veneer. Opening with hidden handle, recessed in the thickness of the front.

DIMENSIONI / SIZE

Comodino 2 cassetti
/ 2 drawers night stand

L 353-453-553-753
__W 13 3/8"-17 7/8"-21 3/4"-29 5/8"
P 436__D 17 1/8"
H 372__H 14 5/8"

Comodino 3 cassetti
/ 3 drawers night stand

L 353-453-553-753
__W 13 3/8"-17 7/8"-21 3/4"-29 5/8"
P 436__D 17 1/8"
H 523__H 20 3/8"

Comò 3 cassetti
/ 3 drawers dresser

L 1439__W 56 3/8"
P 532__D 21"
H 723__H 28 1/2"

Comò 5 cassetti
/ Dresser 5 drawers

L 853__W 33 1/2"
P 532__D 21"
H 1074__H 42 1/4"

\ ELLE #50

Gruppo Notte_Night Set / design: Pierangelo Sciuoto

Pag. 172-173



Gruppo notte con struttura e frontali in particelle di legno caratterizzato da una giunzione a 45° tra top e frontali di sp. 40 mm che sporgono lateralmente rispetto al fianco. Apertura con prensilità laterale. Disponibile in laccato opaco, lucido o in essenza.

/

Night set with structure and fronts made of wood particle board characterized by a 45° joint between top and 40 mm thk fronts. Side handles. Available in matt or glossy lacquered, or wood veneer.

DIMENSIONI / SIZE

Comodino 2 cassetti
/ 2 drawers night stand

L 393-493-593-793
__W 15 1/2"-19 3/8"-23 3/8"-31 1/4"
P 436__D 17 3/4"
H 390__H 15 3/8"

Comò
/ Dresser

L 1245-1479__W 47 1/4"
P 532__D 21"
H 743__H 29 1/4"

Comodino 3 cassetti
/ 3 drawers night stand

L 393-493-593-793
__W 15 1/2"-19 3/8"-23 3/8"-31 1/4"
P 436__D 17 3/8"
H 519__H 20 3/8"

Settimanale
/ Narrow drawer chest

L 893__W 35 1/8"
P 532__D 21"
H 1094__H 43 1/8"

\ JAZZ #51

Gruppo Notte_Night Set / design: Claudio Lovadina

Pag. 174-175



Gruppo notte con struttura e frontali in particelle di legno disponibili in laccato opaco. Frontali realizzati in MDF, caratterizzati da un inserto diagonale. Apertura con prensilità con maniglia a gola sul frontale disponibile in laccato opaco o metal standard.

/

Night set with structure and fronts made of wood particle board, available in matt lacquered. Fronts made of MDF, characterized by a diagonal insert. Opening with groove handle on the front available in matt lacquered or metal standard.

DIMENSIONI / SIZE

Comodino 2 cassetti
/ 2 drawers night stand

L 560-760__W 22"-29 7/8"
P 436__D 17 1/8"
H 376__H 14 3/4"

Comò 3 cassetti
/ 3 drawers dresser

L 1446__W 56 3/8"
P 532__D 21"
H 728__H 28 5/8"

Comodino 3 cassetti
/ 3 drawers night stand

L 560-760__W 122"-29 7/8"
P 436__D 17 1/8"
H 533__H 21 3/4"

Settimanale
/ Narrow drawer chest

L 860__W 33 7/8"
P 532__D 21"
H 1079__H 42 1/2"

\ MEMORIES #52

Gruppo Notte_Night Set / design: Pierangelo Sciuoto

Pag. 176-177



Gruppo notte con struttura e frontali sp. 20 mm realizzati in pannelli di particelle in laccato opaco o in essenza. Bordo interno cassetto con finitura in contrasto metal standard. Apertura con prensilità con gola e basamento H.250 mm in laccato opaco in tinta con la struttura o in metal standard.

/

Night set with 20 mm thick structure and fronts, made of particle board in matt lacquered or wood veneer. Internal drawer edge metal standard finish. Grooved handle and H.250 mm base in nuance matt lacquered or metal standard.

DIMENSIONI / SIZE

Comodino 1 cassetto
/ 1 drawers night stand

L 551__W 21 5/8"
P 420__D 16 1/2"
H 450__H 17 3/4"

Comodino 2 cassetti
/ 2 drawers night stand

L 551__W 21 5/8"
P 420__D 16 1/2"
H 410__H 16 1/8"

Comò 4 cassetti con basamento
/ 4 drawers dresser with basement

L 1427__W 56 1/4"
P 520__D 20 1/2"
H 780__H 30 3/4"

Comò 6 cassetti
/ 6 drawers dresser

L 1427__W 56 1/8"
P 520__D 20 1/2"
H 780__H 30 3/4"

Comò 5 cassetti con basamento
/ 5 drawers dresser with basement

L 851__W 33 1/2"
P 520__D 20 1/2"
H 1238__H 48 3/4"

Settimanale
/ Narrow drawer chest

L 851__W 33 1/2"
P 520__D 20 1/2"
H 1078__H 42 1/2"

\ **GLOBO #53**

Gruppo Notte_Night Set / design: Pierangelo Sciuto

Pag. 178-179



Gruppo notte con struttura realizzata in particelle di legno disponibile in laccato opaco o lucido. Caratterizzato da frontali in multistrato curvato, disponibile anche con top in marmo sp. 20mm. L'apertura con maniglia è incavata nel frontale.

/ Night set with structure made of wood particles, available in matt or glossy lacquered. Globo features curved plywood fronts, also available with 20 mm thick marble top. Handle opening is recessed in the front.

DIMENSIONI / SIZE

Comodino 2 cassetti
/ 2 drawers night stand

L 495__W 21 5/8"
P 495__D 19 1/2"
H 500__H 19 3/8"

Comò 3 cassetti con basamento
/ 3 drawers dresser with basement

L 1407__W 55 3/8"
P 527__D 20 3/4"
H 717__H 28 1/4"

Comodino 2 cassetti con top in marmo
/ 5 drawers dresser with marble top

L 495__W 19 1/2"
P 495__D 19 1/2"
H 508__H 19"

Comò 3 cassetti con top in marmo
/ 3 drawers dresser with marble top

L 1407__W 55 3/8"
P 527__D 20 3/4"
H 725__H 28 1/2"

\ **FULLER #54**

Poltrona_Armchair / design: Presotto Studio

Pag. 182-183



Poltroncina con struttura in legno curvato. Seduta e schienale imbottiti in poliuretano espanso a quote differenziate, rivestito con vellutino resinato 100 gr in fibra di poliestere. Dotata di un basamento integrato che ne permette la rotazione. Rivestimento in tessuto o pelle, disponibile anche nella versione con schienale a contrasto. Non sfoderabile.

/ Armchair with bentwood structure. Seat and backrest upholstered in multi-density polyurethane foam, covered with 100 g polyester fiber resin-coated velveteen. The armchair has an integrated base that allows it to swivel. Upholstery is also available in the dual-coloured version with a rear backrest cover in contrasting finish. Non-removable fabric or leather.

DIMENSIONI / SIZE

L 700__W 27 1/2"
P 725__D 28 1/2"
H 700__H 27 1/2"
H seduta 408__H seat 16"

\ **CLARKE #55**

Chaise Longue / design: Von Robinson

Pag. 184



Poltrona in monoscocca schiumata a freddo e gamba in metallo, dotata di meccanismo basculante. Rivestita in tessuto o pelle non sfoderabile e disponibile con pouf coordinato.

/ Armchair in cold foamed monocoque and metal leg, with tilting mechanism. Seat upholstered in non-removable fabric or leather and available with coordinated pouf.

DIMENSIONI / SIZE

Chaise longue

L 920__W 36 1/4"
P 720__D 28 3/8"
H 910__H 35 7/8"
H seduta 380__H seat 15"

Pouf

L 600__W 23 5/8"
P 420__D 16 1/2"
H 380__H 15"

\ **MILO #56**

Poltrona_Armchair / design: Presotto Studio

Pag. 185



Seduta in multistrato di pioppo con cinghia elastica il tutto rivestito in vellutino resinato 100 gr in fibra di poliestere. Gamba in legno Frassino tinto Nero o tinto Rovere Seppia. Seduta rivestita in pelle o tessuto, non sfoderabile.

/ Seat in poplar plywood with elastic belt, all covered in 100 g polyester fiber resin-coated velveteen. Black stained ash or stained oak leg. Seat upholstered in non-removable leather or fabric.

DIMENSIONI / SIZE

L 720__W 28 3/8"
P 600__D 23 5/8"
H 680__H 26 3/4"
H seduta 390__H seat 15 3/8"

\ DAMA #57

Pouf_Pouf / design: Enzo Mari

Pag. 188-189



Pouf rivestito in cuoio intrecciato a mano.
Disponibile in diverse misure e in numerose varianti di colore.
/

Pouf upholstered in hand-woven leather.
Available in different sizes and colors.

DIMENSIONI / SIZE

L 460__W 18 1/8"
P 460__D 18 1/8"
H 420__H 16 1/2"

L 1000__W 39 3/8"
P 1000__D 39 3/8"
H 420__H 16 1/2"

\ PILAR #58

Pouf_Pouf / design: gherardiarchitetti

Pag. 190-191



Pouf in legno curvato, imbottiti in tessuto, ecopelle o pelle non sfoderabili.
Disponibile con vassoio d'appoggio opzionale in laccato opaco o impiallaciato in essenza.
/

Pouf in curved wood, upholstered in non-removable fabric, eco-leather or leather. Available with optional matt lacquered or wood veneer tray top.

DIMENSIONI / SIZE

Ø 490__Ø 19 1/4"
H 380__H 15"

\ QUADRATO #59

Pouf_Pouf / design: Presotto Studio

Pag. 192-193



Pouf cubico disponibile in tessuto, ecopelle o pelle; sfoderabile. Dotato di piedini d'appoggio.
/

Cubic pouf available in fabric, eco-leather or leather; removable cover. Equipped with support feet.

DIMENSIONI / SIZE

L 390__W 15 3/8"
P 390__D 15 3/8"
H 435__H 17 1/8"

\ DORMEUSE #60

Panca_Bench / design: Enzo Mari

Pag. 194



Panca con struttura in legno di rovere rivestita in cuoio naturale conciata al vegetale, disponibile in diverse varianti di colori. Gambe verniciate nero opaco. La panca è dotata di un comodo poggiatesta cilindrico in cuoio su richiesta.
/

Bench with oak structure, upholstered in natural vegetable-tanned saddle leather, available in several color variations. Legs are in matt black powder coated metal. The bench is equipped with a comfortable cylindrical leather headrest upon request.

DIMENSIONI / SIZE

L 1800__W 70 7/8"
P 600__D 23 3/8"
H 420__H 16 1/2"

Testiera / Headrest

L 450__W 17 3/4"
P 150__D 5 7/8"

\ SIGMUND #61

Panca_Bench / design: Enzo Mari

Pag. 195



Panca con struttura in legno di rovere, rivestita in cuoio naturale conciato al vegetale ed intrecciato a mano. Gambe verniciate nero opaco. La panca è dotata di un comodo poggiatesta cilindrico in cuoio su richiesta. Disponibile in diverse varianti di colori.

/ Bench with oak wood structure, upholstered in natural vegetable-tanned and hand-woven leather. Legs are in powder coated matt black. The bench is equipped with a comfortable cylindrical leather headrest upon request. Available in different color variations.

DIMENSIONI / SIZE

L 1800__W 70 7/8"
P 600__D 23 3/8"
H 420__H 16 1/2"

Cuscino / Cushion

L 450__W 17 3/4"
P 150__D 5 7/8"

\ CALI #62

Panca_Bench / design: gherardiarchitetti

Pag. 196-197



Panca con struttura realizzata in pannelli di particelle, rivestita in tessuto, ecopelle o pelle non sfoderabile, disponibile in diverse varianti di colori. La panca è caratterizzata da un cuscino espanso e falda accoppiata sempre rivestito in tessuto, pelle o ecopelle, sfoderabile. Basamento costituito da piedi metallici di sezione circolare in metal standard.

/ Bench with particle board structure covered in non-removable fabric, eco-leather or leather. Available in many colors. The bench is characterized by a foam cushion and coupled flap covered in removable fabric, eco-leather or leather. Metal feet of circular section in metal standard.

DIMENSIONI / SIZE

L 1500__W 59"
P 500__D 17 3/8"
H 415__H 16 3/8"

\ CADDY #63

Scrittoio_Writing Desk / design: Estel Studio

Pag. 200-201



Tavolo-scrivania-contenitore su ruote con piano di lavoro in multistrato di betulla da 18 mm. L'altezza del piano regolabile, da 740 a 120 mm grazie ad un pistone a gas attivabile con maniglia posizionata sottopiano. Struttura in metal standard, antine laccato opaco. Disponibile con power bank da 13.000 Mha per alimentare le prese USB integrate nella struttura.

/ Storage table on wheels with work tops in 18 (3/4") multilayer birch. Height-adjustable top can skip from 740 to 122-mm thanks to a gas cylinder, using a handle under the top. Metal standard structure, matt lacquered doors. Available with 13.000 Mha power bank for integrated usb socket.

DIMENSIONI / SIZE

L 900__W 35 3/8"
P 900__D 35 3/8"
H 740-1220__H 29 1/8"-48"

\ RELEVÈ #64

Scrittoio_Writing Desk / design: gherardiarchitetti

Pag. 202-203



Struttura realizzata in legno naturale impiallacciato in essenza, con piano incassato a filo nella struttura disponibile in essenza, vetro liscio o satinato retrolaccato o ceramica. Altezza piano 750 mm; struttura disponibile in: rovere dark, rovere tabacco o noce canaletto.

/ Structure in natural wood with wood veneer, with a flush built-in top in the structure available in veneer, glossy or satin back-lacquered glass or ceramic. Top height is 750-mm; structure is available in: dark oak, tobacco or canaletto walnut, back lacquered glass or ceramic.

DIMENSIONI / SIZE

L 1250__W 49 1/2"
P 590__D 23 1/4"
H 750__H 29 1/2"

\ SQUID #65

Scrittoio_Writing Desk / design: Francesco Favaretto

Pag. 204-205



Scrivania con basamento alluminio in finitura epossidico nero o metal standard. Piano in finitura essenza o laccato opaco, spessore 22 mm. È possibile applicare uno scudo H.450 mm rivestito in cuoio o ecopelle.

/ Writing desk with aluminum base in black epoxy or metal standard finish. 22-mm thk top in veneer or matt lacquered finish. It can be setted with a H.450 mm shield covered with saddle leather or eco-leather.

DIMENSIONI / SIZE

L 1230__W 49 ½"

P 600__D 23 ¾"

H 920__H 36 ¼"

\ BLOOM #66

Scrittoio_Writing Desk / design: Arnaldo Gamba

Pag. 206-207



Scrivania a forma di plettro con struttura verniciata metal standard peltro su 3 gambe, rinforzate da profili orizzontali. L'intera struttura è avvolta sui due lati da fianchi curvi in finitura eucalipto dark H.400 mm. Piano (spessore 110 mm) rivestito in cuoio: nero, cuoio naturale, sabbia.

/ Plectrum-shaped writing desk with pewter metal standard structure on three reinforced legs with horizontal profiles. The entire structure is covered on both sides by curved sides in dark eucalipto wood H.400 mm. 110 mm thk top is covered in saddle leather: black, natural leather, sand.

DIMENSIONI / SIZE

L 800__W 31 ½"

P 600__D 23 ¾"

H 850__H 33 ½"

\ MIMESI #67

Specchio_Mirror / design: gherardiarchitetti

Pag. 208-209

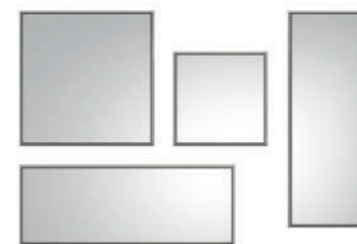

Specchiera a parete caratterizzata da una cornice smussata in legno verniciato metal standard.

/ Wall mirror featuring a lacquered wood, bevelled metal standard frame.

DIMENSIONI / SIZE

L 800__W 30 ½"

P 58__D 2 ¼"

H 1800__H 70 ¾"

L 1600__W 63"

P 58__D 2 ¼"

H 600__H 23 ¾"

L 1000__W 39 ¾"

P 58__D 2 ¼"

H 1000__H 39 ¾"

L 700__W 27 ½"

P 58__D 2 ¼"

H 700__H 27 ½"

\ TUTTOSPECCHIO #68

Specchio_Mirror / design: Pierangelo Sciuto

Pag. 210-211



Struttura in pannello tamburato formato da telaio in pannelli di particelle rivestito con specchi giuntati a 45° su 5 lati; la specchiera appoggia a terra su piedini in metallo cromato.

/ Structure in honeycomb panel formed by frame in particleboard panels covered with mirrors joined at 45° on five sides; feet in chromed metal.

DIMENSIONI / SIZE

L 800__W 30 ½"

P 80__D 3 ⅛"

H 2200__H 86 ⅝"

